

 StewMac®

1937 Pre-war Dread-28 Acoustic Guitar Kit

#WRM3JV Assembly Instructions



Table of contents

Getting started

Welcome to guitar building!	5
Recommended tools and supplies	6
Kit parts list	7

Side Assembly

Assembling the sides	8
Making a body mold	9
Installing the side reinforcing ribbon	10
Installing kerfed linings	10
Squaring the neck block and tailblock	10
Leveling the kerfed linings	11

Soundboard bracing and fitting

Installing the soundhole rosette	12
Installing the soundboard bracing	13
Bridge and shoulder brace clamping cauls	15
Fitting the soundboard to the sides	16
Installing the soundboard	18

Back bracing and fitting

Installing the back bracing	19
Fitting the back to the sides	20
Installing the back	20

Routing and binding

Trimming the top and back overhang	21
Routing for the plastic body bindings	21
Installing the end trim	23
Installing the bindings	23
Opening the dovetail joint	24

Fit and fill the truss rod channel

Fitting the truss rod	25
Fill the channel.....	25

Peghead shaping and drilling

Peghead overlay	26
Shape the peghead	26

Making a fretboard

Trimming the fretboard	27
Inlaying the fretboard	27
Installing the fretboard side dots	28
Installing the frets	28
Installing the fretboard	29

Neck shaping and fitting

Shaping the neck	30
Installing the nut	30
Fitting the heel cap	31
Understanding the neck joint	31
The neck heel sets the neck angle	32
Fitting the neck to the body	32
Neck adjustment: side-to-side	33
Neck adjustment: tilt the neck back	33
Neck adjustment: tilt the neck up	34
Tightening the dovetail joint	34
Installing the last frets	34

Finishing

Introduction to finishing and materials	35
Sanding the body	35
Filling the fret ends	36
Sanding the neck	36
Spray handles and hangers	36
Masking the neck and body	36
Staining	37
Applying a washcoat to seal the wood	37
Filling the wood grain pores	37
Lacquer spraying schedule	37
Sanding and rubbing-out the finish	38

Final assembly and setup

Prepare for neck installation	39
Install the neck	39
Prepare for bridge installation	39
Installing the bridge	40
Fitting the bridge pins.....	40
Fitting the bridge saddle	41
Installing the tuning machines.....	41
Seating the strings	42
Understanding neck relief	42
Adjusting string action: nut slots & saddle height	42
Leveling the frets	43
Installing the pickguard	44
Installing the endpin and strap button	44
CONGRATULATIONS!	44

Getting started

Welcome to guitar building!

You've probably dreamed about owning a pre-war herring-bone dreadnought. Most of us have. Many guitarists consider these instruments to be the greatest acoustic guitars ever built. However, the originals are VERY expensive, and VERY hard to find. Those two facts alone make these guitars inaccessible to most musicians.

However, while you might not be able to BUY one, you can BUILD one (or at least a very accurate replica). We've meticulously reproduced an original pre-war 1937 Dread-28, down to the smallest detail!

Not only does the StewMac Icon Guitar Kit capture the correct period LOOK of the original, but it also faithfully reproduces the "bones" of the instrument, so you can get as close as possible to that authentic, revered tone.

When you're done with this project you'll have a true heirloom that you'll enjoy for years and proudly pass down to future generations.

We designed this kit for the small shop builder with a modest tool budget. With the exception of a few specialty guitar making tools, you probably already own most of the items you'll need to build this guitar.

A few notes before you get started:

Please read all of these instructions before starting your build. The instructions and plans were developed specifically for this kit. The video that's included covers the essential steps for building an acoustic guitar, but it was developed for our standard acoustic guitar kits, not this pre-war Icon kit. Therefore, you should always reference these instructions and the included blueprint for specific details while building your Icon.

Speaking of the blueprint; modern printing technology doesn't always faithfully reproduce measurements down to the tolerances we need in guitar building. As a result, always refer to the printed measurements versus measuring the template directly. As small as these differences are, they can make a difference.

And finally, while you're probably excited to get started, you need to take a little time to acclimate your kit. Thin pieces of wood (like the ones you find in acoustic guitars) are extremely sensitive to changes in humidity and temperature. The ideal building environment is 70-80° Fahrenheit (21-26° Celsius), with a controlled relative humidity of 45-50%. The woods in your kit should be laid out and allowed to acclimate in your shop for one week before you start your build. Flip the wood daily to neutralize excessive warping.

Depending upon your location and the season, you may need to humidify or dehumidify your shop to maintain the desired relative humidity. It is highly advisable to purchase a decent quality thermometer/hygrometer to monitor your shop's climate. If you're unable to control the relative humidity in your shop, we discourage building the guitar during the transition from dry to wet seasons, or vice versa.

Radical changes in humidity, especially during season changes, can cause warping, splitting and other serious complications. You're going to put a lot of love into this build and this small preventive effort is well worth the extra effort.

And finally, be safe when using tools, glues, and chemicals. Wear eye protection and gloves when needed, and always use proper ventilation.

Congratulations. We wish you all the best on your build, and remember, if you get stuck or have any questions along the way call us. We're here to help.

Recommended tools and supplies

The following tools and supplies are recommended to assemble your kit. Though all of these tools aren't necessary to build your kit, they make many assembly steps easier and more professional. Where applicable, item numbers for ordering from StewMac are included.

For binding installation, you have a couple of different options to choose from depending on the tools you already own. If you plan on using a laminate trimmer or router for binding channels, we suggest our Binding Router Bit (#1298-B) and bearings (#1298-060, 1298-200). It is our preferred method. If you plan on routing your binding channels with a Dremel tool, our Precision Router Set (#5263) ships with everything you will need.

Tools

Electric hand drill
Coping saw
Center punch or awl
Glue brushes #4167
6" Steel rule #4894
1/2" Chisel #1623
File set #0842
Small rasp #4154
Fret Leveler #0862
Dressing stick #1939
Fret cutter #0619
Deadblow fret hammer #1296
18" Straightedge #3850
.020" gauged saw #3572
Scraper blade #0654
4mm Allen wrench #6113
Nut-slotting files: 0.016" width (#0827)
and 0.035" width (#0832)
1/4"-diameter bit #4850
Bridge pin reamer #3227
Fret dressing file, medium # 1602
Radius-sanding block, 16" radius #0413
Small cam clamps (at least 2) #3724
Large cam clamp (2) #3725
Spool clamps (24) #3715
Clothes pins (50)
Medium bar-style clamp (2) #3714
X-Acto knife
Small carpenter's square
Feeler gauges #1811

StewMac has easy-to-order sets of tools that kit builders find most useful.

Search "acoustic kit tools" at stewmac.com

Supplies

3/4" plywood workboard 24" x 20"
Bind-ALL Binding Glue #1976
Titebond Glue #0620
Fish Glue #0702
Super Glue (#0010 thin and #0020 medium)
Double-stick tape #1689
Low tack protective tape #1682
Masking/binding tape (high tack) #0584
Rubber binding bands #1256 (option to using binding tape)
Sandpaper (80, 100, 150 and 220-grit)
Wax paper
White pencil
Felt-tip marker
Capo #4571
Clean cotton glove

Finishing materials (for aerosol nitrocellulose lacquer finish)

Guitar Finishing Step-By-Step book #5095
Fre-Cut® sandpaper 150, 220, 320, 600, 800, and 1200-grit
at least 2 sheets of each grit (included in Finishing
Paper Sampler Package #5562)
ColorTone Concentrated Liquid Stain (tobacco brown #5034,
red mahogany #5032)
ColorTone Grain filler
ColorTone Clear Gloss aerosol nitrocellulose lacquer (6) #3881
Blush Eraser #1313
StewMac Polishing Compound medium #1202 and fine #1203
StewMac Swirl Remover #1204 (optional)
Foam Polishing Pads (2 or 3) #3414 and electric hand drill
Naphtha solvent #0775
Paint stripper
Masking supplies: brown paper, masking tape, cardboard
and rubber balloon (or newspaper) for soundhole

Kit parts list



- 1 Back brace set (9 pieces)
- 2 Waverly Tuning Machines
- 3 Mahogany neck, dovetail
- 4 Hot Rod truss rod
- 5 Soundboard brace set (11 pieces)
*Wide, flat brace not used.
See page 14 for details
- 6 Shim stock
- 7 Rosewood bent sides
- 8 Rosewood back
- 9 Red spruce soundboard
- 10 Fretwire (3)
- 11 Pickguard
- 12 Bridge
- 13 Neck block, dovetail
- 14 Tailblock
- 15 Slotted fretboard
- 16 Fret markers (7)
- 17 Purfling for rosette
- 18 Herringbone purfling (2)
- 19 Purfling strips (2)
- 20 Binding (4)
- 21 Bridge pins (6) and endpin
- 22 Strap button
- 23 White side dot material
- 24 Bone saddle
- 25 Bone nut
- 26 Rosewood peghead overlay veneer
- 27 Maple bridge plate stock
- 28 End trim, heel cap
- 29 Reinforcing ribbon
- 30 Tail block strip
- 31 Cheesecloth
- 32 Kerfed lining (8)
- 33 Cardboard body form (2)
- 34 *Building an Acoustic Guitar Kit* DVD
- 35 Blueprint
- 36 Bracing pattern

Not pictured: this assembly instructions book, scrap wood, and large rubber band.

Side Assembly

Assembling the sides

Each bent guitar side has been formed from a tapered piece of wood. One of the longer edges is straight (the guitar top) and the other is slightly curved (the back). Place the sides, **straight edges down**, on the workboard and butt the ends together. The sides shouldn't rock on the workboard surface. Pencil accurately measured centerlines on the neck block and the tailblock, and align these marks against the inner seams of the adjoining guitar sides. The open top of the neck block must face **downward against the workboard**, and both blocks must be flush with the sides at the top and bottom.

Dry-clamp the two blocks to the sides, place a piece of wood across the waist, and rest a weight (a couple of bricks worked for us) on the piece of wood (**pictured**) to keep the sides flat against the cardboard. Now readjust the neck block and tailblock while the sides are weighted down.



KIT TIP: Dry clamping

It's important to try fitting and clamping the kit pieces before you use glue. Practice a "dry run" to make sure you have all the clamps and cauls needed before glue is applied. We found that using a little brush (like our Glue Brush) helps to apply the glue evenly on the surface.

The back side of the neck block has a fairly steep 5° angle to match the arch of the back. Viewed from the side, in cross-section, both ends of the neck block are flush where they meet the sides, but the 5° side will be higher than the sides as it tapers up toward the interior of the guitar.

The side of the neck block that touches the guitar sides is curved. A clamping caul with matching curvature (**illustrated**) should be prepared from scrap wood and placed against the outer side seam. The same caul will fit both the neck block and tailblock areas.

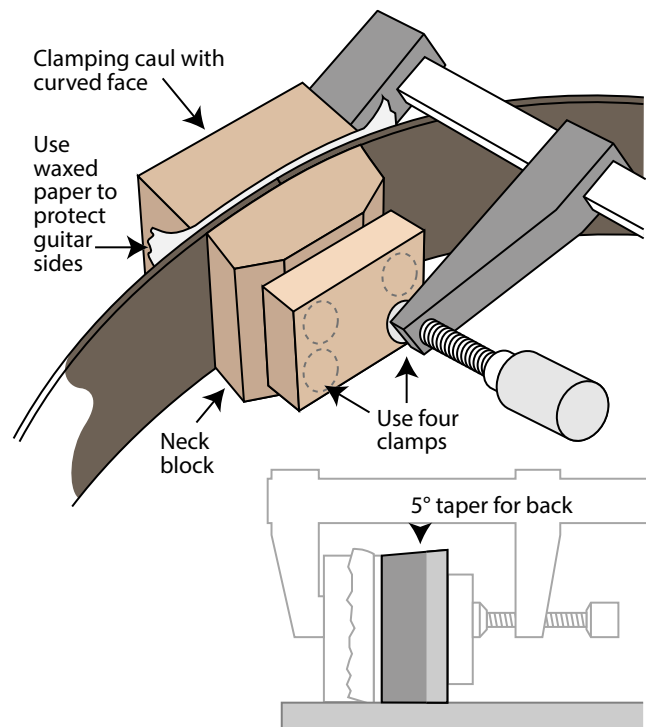

KIT TIP: Cauls

You'll need scrap wood to make cauls that will be used throughout assembly. Cauls are used to apply uniform pressure while the glue dries, and to protect the guitar's surface from the clamps.

Remove the clamps and, one at a time, apply Titebond glue to the inner block surfaces. Reclamp using four clamps per block. Wipe off the excess glue with a damp cloth and let the assembly dry overnight before unclamping. Use waxed paper to prevent the wooden parts from being glued to the cardboard surface.

After unclamping the neck block and tail block, draw a center line on the maple tailblock reinforcement strip, and also on the top and bottom of the tailblock. On the side of the tailblock that contacts the back, measure down 3/16" make a mark (this is for clearance for the back center strip). Apply glue to the maple reinforcement strip and place the centerline on the marks on the tailblock and to the edge of the 3/16" mark.

Making a body mold

Using the two heavy cardboard body forms (supplied with the kit) create a guitarmaking form which supports the body during the early stages of assembly.

First, place two scraps of 3/4" plywood onto the work surface inside the guitar. This will lift the cardboard form up to make room for the kerfed linings which will be installed later. Lay the first cardboard piece onto the 3/4" plywood inside the guitar body.

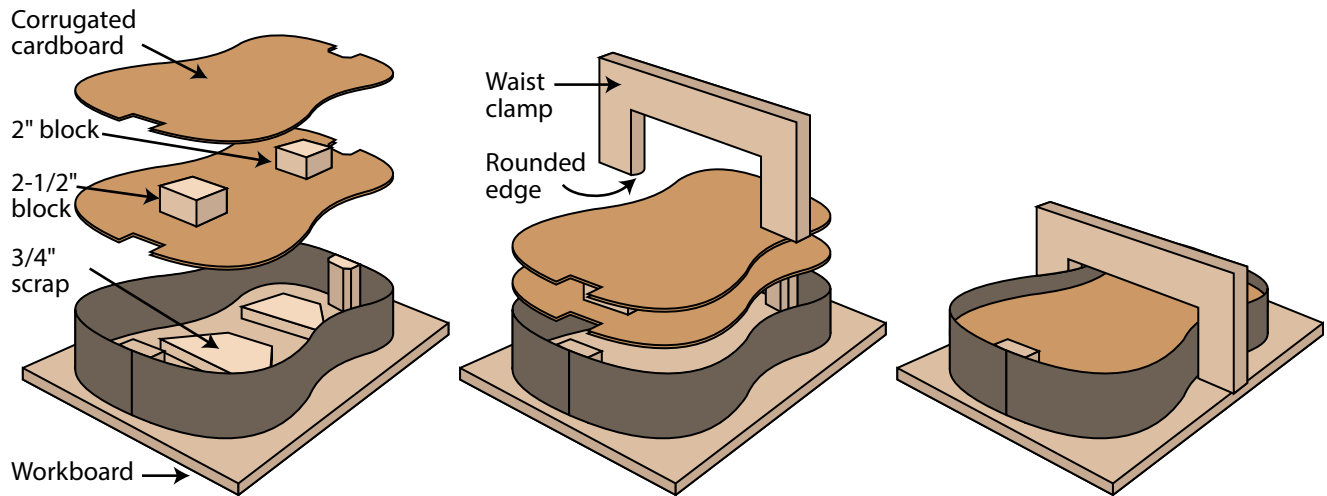

Next, glue a 2" thick block of scrap wood onto the cardboard, centered about 4" from the smaller end of the guitar mold. Then glue a second 2-1/2" piece of scrap wood, centered about 4" from the bottom (larger end) of the guitar mold. Glue the second piece of cardboard onto them. Now the two cardboard forms are fastened together with blocks of wood between them, creating a three-dimensional form for supporting the guitar sides.

Make a U-shaped waist clamp from 3/4"-thick plywood, using the waist clamp measurements (**illustrated**). The purpose of the waist clamp is to hold the guitar's waist tight to the inner cardboard mold, maintaining a constant shape until the back is glued on.

Use a file to round the two inner edges of the waist clamp to remove edges and protect the guitar sides.

To start out, install the waist clamp from the back side of the guitar. (Later, after the top is installed, you'll switch the waist clamp to the top side) When sliding the waist clamp on, hold the guitar sides tight against the cardboard form to keep from cracking the sides. If the fit is too tight, remove small amounts from each side of the U-shape until the waist clamp slides snugly onto the waist (but not so snug that it's hard to remove).

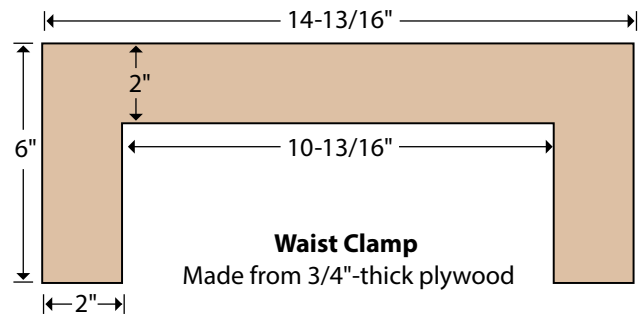

Installing the side reinforcing ribbon

The blueprint included with your kit illustrates the positions of vintage-style cloth side reinforcing ribbon. Transfer the centerlines of the reinforcement strips from the blueprint to the inner sides of your kit. Measure, mark and cut eight strips for each side from the ribbon supplied with your kit. Each strip should go from the back edge of the sides to the top edge so the kerfed lining will be later glued over top of the ribbon (**pictured**). Mark the centerline on the ribbon on the ends of the ribbon with a marker (only on the area that will be covered by the kerfed linings). With a glue brush, apply a thin film of fish glue (you don't want any glue squeeze out) on the back side of the ribbon and place it on the transferred centerline. Use a piece of wax paper on top of the ribbon to smooth it out and apply pressure. You shouldn't need any type of clamping but if they try to curl up, use strips of binding tape to hold them flat then carefully peel the tape off after 24 hours.



Installing kerfed linings

Eight kerfed (notched) wooden lining strips are supplied for reinforcing the glue joints between the soundboard, sides and back. Refer to the blueprint; dry-clamp (no glue) the linings to the top edge of the side assembly using ordinary spring-tension clothespins (**pictured**).

Each side of the guitar requires two strips, which should be accurately trimmed where they meet the body blocks. Use at least four or five dozen clothespins. The top (gluing) surface of the linings should extend 1/32" above the edge of the guitar's sides, on both the top and back sides.

The linings are left slightly proud so that you'll have a little wood to sand off until the linings comes perfectly flush with the top edge of the sides, and to make up for any possible misalignment during glue-up.

Disassemble, trim the linings, glue them into place with

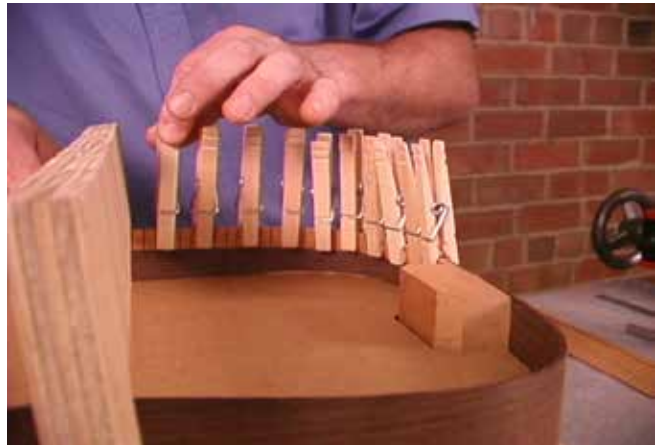

Titebond, check the 1/32" clearance and reclamp. Let the glue dry for 4 hours. Install the lining strips on the back edge of the side assembly in the same manner.

Squaring the neck block and tailblock

Although they work quite well, the waist clamp and cardboard inner body mold still allow some movement. Handle the rim assembly carefully, especially until the top and back are glued on and the assembly becomes more rigid. Lay the rim assembly topside-down on the plywood work surface, weight it down again, and use a square at each end to see if the neck block and tailblock are square to the plywood surface. If either end is slightly out of square, use a thin tapered wedge pressed between the cardboard inner body mold and either the neck block or tailblock as needed, to force the blocks and sides into square (**pictured**). Having the sides properly squared up at this stage is important.



Leveling the kerfed linings

Prepare a “sanding board” from a straight flat piece of wood about 3-4" wide, at least 1" thick, and 24" long (**illustrated**). Add a 5° wedge on one end of the sanding board. This wedge will tip the sanding board to match the angle of the back as you sand the kerfed linings, neck and tailblock. The wedge should be approximately 8" long, and as wide as the sanding board. At the opposite end, stick 80-grit sandpaper to both sides of the board using double-stick tape.

Rest the side assembly, with the straight top edge down, on the flat surface of your workbench. The front shoulders should overhang the bench, so that the waist clamp can be fastened to the edge of the benchtop with two wood screws. If you're unable to screw the waist clamp to the bench, clamp a board flush to the bottom edge of your bench, and clamp or screw the waist clamp to the board.

Draw a white pencil line on the edge of the guitar sides to serve as an indicator of your sanding progress. Stop sanding when the line is gone and you begin to graze the sides. Hold the wedged end of the board against the tailblock as a pivot point, and begin sanding the neck block and the front shoulder area first. Work around the sides to the tailblock, **moving the pivot point frequently**, until the sandpaper begins grazing the white pencil marks on the top edge of the sides. It's easy to oversand the sides and the kerfed linings, leaving the neck block or tailblock higher than the sides, and causing a “hump” in that area later. Keep this in mind, and give the blocks a little extra sanding. White pencil them several times and use a straightedge to be sure they are flat.

Move the waist clamp to the back side of the rim assembly, and refasten the clamp to the bench with the top kerfed linings facing up. Repeat the sanding process, but this time using the flat side of the sanding board. The top kerfed linings are easier to sand than those on the back of the rim. When your sanding reaches the white pencil line, the linings are ready for the guitar top to be fitted.

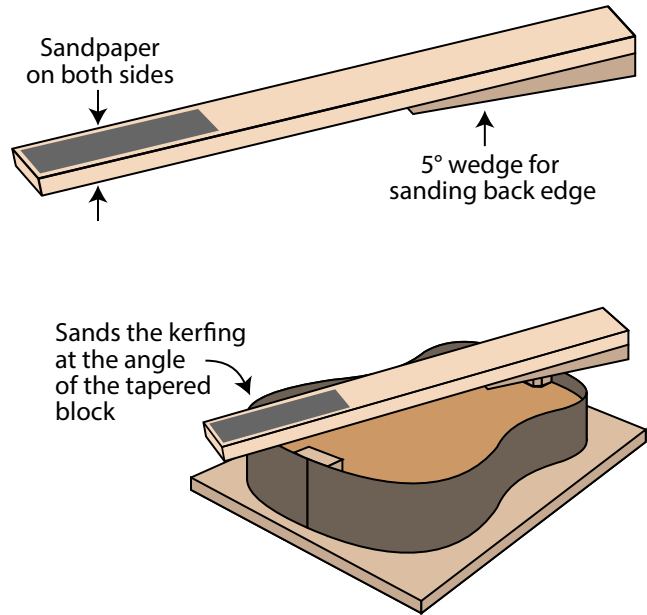

KIT TIP: Back kerfing

The back kerfed linings can be level-sanded **AFTER** the top is glued to the sides. The rigidity added by the glued top makes the sanding easier and more accurate. If you choose this option, level the top kerfed linings first (**pictured**), and sand the back linings just before removing the cardboard inner mold.

Soundboard bracing and fitting

Installing the soundhole rosette

The soundhole rosette is made up of multiple black and white purfling strips. DO NOT separate the purfling strips until you are ready to dry fit and glue. The strips that make up the rings have the ends taped together for you to keep them in the proper order. The strips are also grouped for you in the sets that make up the three rings.

We suggest taping the middle with a very thin tape in the middle to make dry fitting easier. Pay close attention that the separate pieces that make up each ring do not get out of order. Consult the diagram if you get them out of order.

The purflings are longer than needed, to enable the removal of the straightened ends on each ring left from the bending process. Note the outer rings will be hidden, but the smallest/inner ring will be exposed. Practice the trimming on the hidden ones first, you want to get the exposed one perfect. A few extra minutes of careful work here will make a big difference in the appearance of the final instrument.

Glue the purflings in place with Bind-ALL and press them firmly into the channels. A flat clamping caul covered in wax paper will seat them well. After drying, scrape the purflings flush to the surface of the soundboard, using a sharp scraper blade. Flex the scraper slightly as you work, and trim the purflings until the tool begins to pick up bits of spruce. You can also use a flat block of wood wrapped with a piece of 150-grit sandpaper.

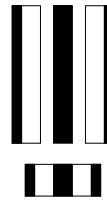
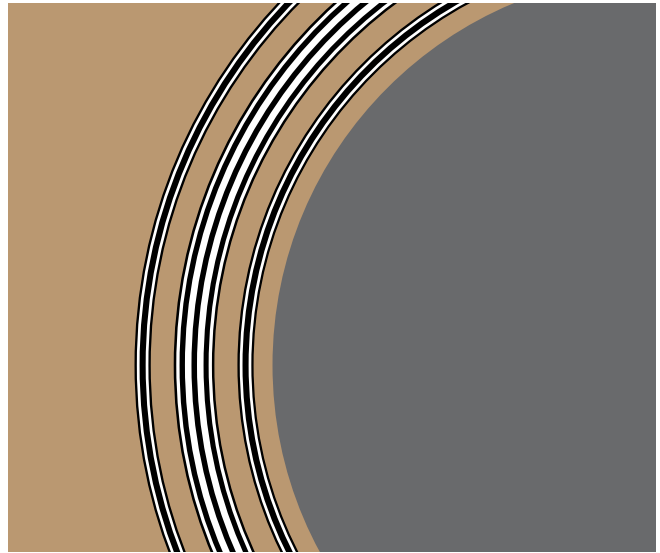

Inner and Outer Rings

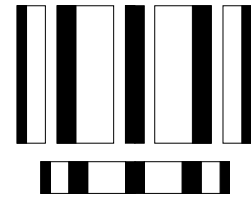

Center Ring

Installing the soundboard bracing

Using the Dreadnought Forward X Bracing pattern provided (NOT the blueprint), pencil the soundboard bracing pattern (**pictured**) on the inside surface of the soundboard (cut small holes in the pattern at the corners and intersections of the braces, lay the pattern on the soundboard, transfer the hole positions in pencil, and “connect the dots” on the soundboard when the pattern is lifted away). The pattern **MUST** be correctly centered along the soundboard’s center seam, with the soundhole properly located. Note that the soundboard and the back have been trimmed to allow about 1/8" overhang all around. This offers a little freedom when assembling the top and back to the rim, and will be trimmed away later.

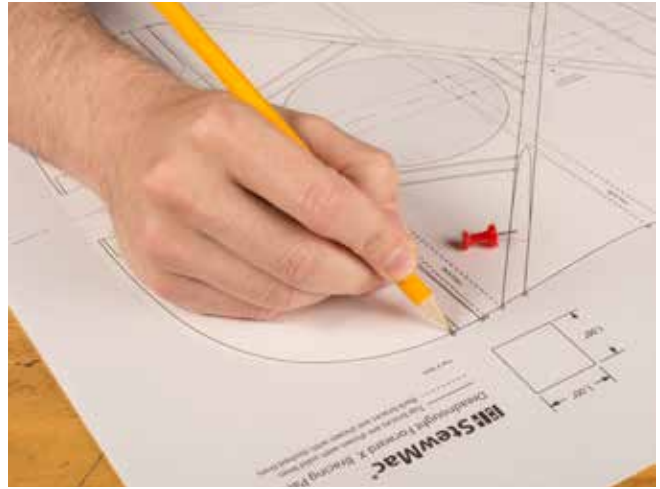

Identify your soundboard braces: the two long X-braces (T-1 on the blueprint), the tall front shoulder brace (T-5), and the tone-bars (T-2) are radiused. The four small braces (T-3) are not radiused. The wide flat brace (T-6) is not used on this model guitar, you can discard it.

With the soundboard face down on your workboard, place these two X-braces on the penciled lines and mark where they cross. With a razor saw, notch the radiused T-1 braces so they interlock. Using the rigid workboard, dry-clamp the ends in place, flat to the soundboard (**pictured**). Clamp the center of the "X" down, using one or two long cam clamps. The combination of the curved braces and the rigid workboard will produce the proper soundboard arch (a 28-foot radius) when the clamps are removed.

As shown in the blueprint, the ends of the T-2 tone-bars, the four small T-3 braces, and the maple bridge plate tuck under the X-braces. File these notches in the X-braces at a 45° angle (**pictured**). Using a sharp chisel, carefully shape a matching angle on one end of these braces where they tuck under. Reclamp the X-braces onto the soundboard and workboard. Check the fit of the tone bars in the notches. Disassemble, apply Titebond to the braces and tone bars, reclamp, and let the glue dry overnight. This work can be done in stages, depending upon the number of available clamps. Use two flat clamping cauls for each pair of tone bars, with the soundboard resting on your workboard to keep it flat at this stage (**pictured**). Cut the three flat sound-hole reinforcement strips (T-4) to length and glue them into position on the soundboard.

Transfer the outline of the bridge plate from the bracing pattern to the flat maple bridge plate stock. Saw out the plate and true its edges against a piece of sandpaper taped to a flat work surface. Don't drill the bridge pin holes yet; this will be done later. File a 45° bevel at each end of the bridge plate and check for proper fit in the X-brace notches. File off each pointed end of the bridge plate so that it can slide forward as it tucks under the X-braces. Prepare a wooden clamping caul to fit snugly over the installed bridge plate between the X-braces, and glue the plate onto the soundboard with Titebond or hide glue. The lower clamp jaws should contact the back of your workboard to protect the spruce soundboard.

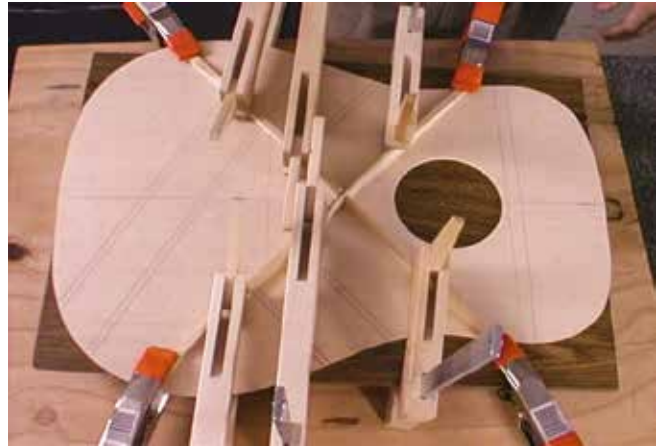
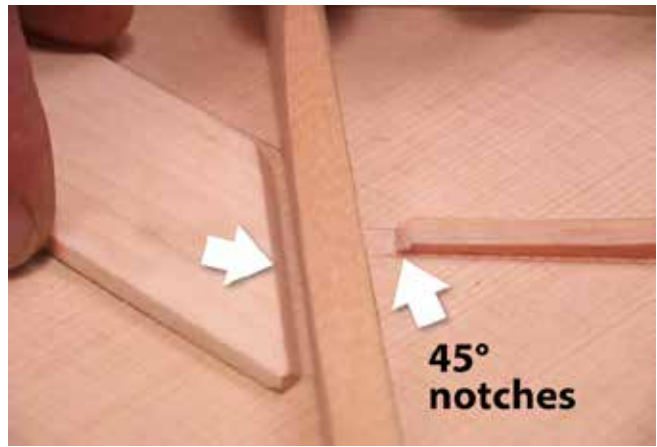

Place the two supplied pieces of cheesecloth on top of each other and cut into approximately a 1-1/2" circle. Keep the two pieces together and apply glue to one side of the cheesecloth, then place the cheesecloth (glue side down) over the intersection of the X braces (**pictured**). Use a small screwdriver or scrap of the wood soundhole reinforcement to push the cheesecloth into the corners on the sides of the X brace intersection. Let this dry overnight and trim any protruding strings with a razor knife for a clean look.



Bridge and shoulder brace clamping cauls

While the braces are accessible, prepare a bridge clamping caul and a shoulder brace caul that will be used in the "Installing the neck" and "Installing the bridge" sections. The bridge caul (**illustrated**) is 7-1/2" x 1-3/4" x 3/4". It must be relieved to contact the bridge plate and the soundboard, and have sufficient relief to clear the X-braces and the tone bars. The easiest way to create this relief is to glue scrap corners from the bridge plate itself onto the corners of the caul. This way, the caul's center portion is relieved by an amount equal to the thickness of the bridge plate.

The shoulder brace caul is 2" x 2-5/8" x 1-1/4", with relief to clear both shoulder braces. Use a saw and a chisel or router to make these cauls.

Bridge clamping caul

These surfaces must contact the soundboard; the notches should not contact the braces.

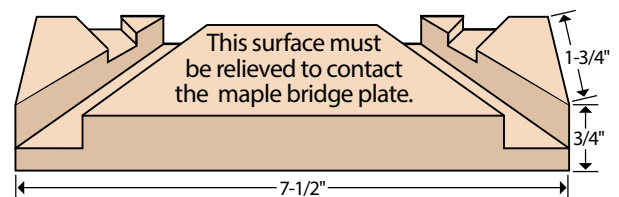

Shoulder brace caul

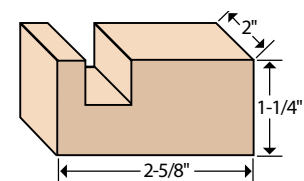

Fitting the soundboard to the sides

To fit the top, the ends of the X-braces and the tall shoulder brace must be notched into the kerfed linings. The remaining smaller braces will be tapered to nothing where they meet the kerfing.

KIT TIP: Tapering smaller tone bars

The blueprint shows the ends of the T-2 tone bars notched into the kerfing, but we now suggest that you taper them before they reach the kerfing. The choice is yours. Tapering these braces to nothing will let the top flex a little more.

For this fitting, leave the side assembly clamped to the workbench if you're able to work around the assembly comfortably. You can unclamp the side assembly and the waist clamp from the workbench if it makes fitting the top easier, but be sure to handle the assembly gently. Don't bend or twist the sides as you fit the top.

Chisel the ends of the X-braces and tall shoulder brace down to a thickness of .100" (**pictured**). Follow the pre-machined taper of the braces as you chisel.



To find the guitar's accurate length between neck and tailblocks, first measure 3-15/16" from the top edge of the soundhole, towards the neck block (**illustrated**). Make a pencil mark on the centerline, on the underside of the soundboard. Measure 20" from this mark to the tailblock end, and make a mark. This is the **body length**. During gluing, these marks must align with the sides and blocks. The soundboard will overhang the sides a little, which will be trimmed away later.

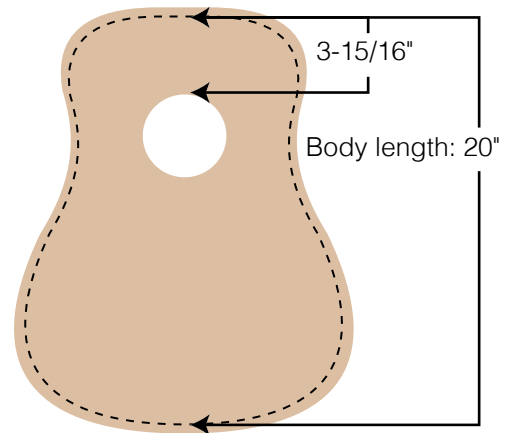

KIT TIP: Trimming soundboard overhang

An option to leaving the top overhang is to remove it in the neck block and tailblock areas only. This gives you an opportunity to re-check the squareness of the sides to the top in these areas during gluing. If you trim the overhang flush, then during gluing, you can butt the top and sides at each end until they are flush to ensure squareness. This way, the top fits the sides, neck block and tailblock accurately, and you can ensure that the body measures 20" from end-to-end.

Using a 3/4" x 2" x 3" scrap wood caul and two cam clamps, gently dry-clip the top to the neck block. Next (if necessary), pull the sides and tailblock into the body length pencil mark (look at the mark on the underside) and gently dry-clip that end. Don't use excessive pressure, since the braces to be notched will be resting on the kerfed lining at this point. On the guitar's sides, use a white pencil to mark the end positions of the X-braces and the large shoulder brace. Remove the soundboard and trace the brace positions onto the kerfed linings with a straightedge, using the marks as reference points. For the X-braces, be sure to hold a long straightedge between the reference points at the proper angle shown in the blueprint. The positions of the tone bars should also be marked if you choose to notch them. The tone bars don't notch in as deep as the other braces, and only a slight filing will be needed.

With a knife and/or file, remove wood from the linings and the sides in the penciled areas to accommodate the ends of the braces. These notches should taper toward the interior of the guitar to match the taper of the braces (**pictured**). When the notches are cut correctly, the top will fit into place and be ready for gluing.



Installing the soundboard

With the waist clamp still in place on the side assembly, and with the assembly resting top-down on the flat plywood, recheck the squareness of the neck block and tailblock to the sides. Make slight adjustments if necessary by adding or removing a wedge of wood between the blocks and the cardboard. Turn the guitar over so the top faces upward. Handle the assembly carefully now, until the top is glued on!

When gluing the soundboard and the back onto the sides, use C-clamps, or cam clamps as pictured, at both ends, with plenty of spool clamps in between. Carefully prop up the backside, on each side of the waist clamp, with small boxes, blocks of wood, or anything that will lift the waist clamp clear of the table, to allow clamping access at each end. When the neck block and tailblock are clamped, and a few spool clamps are in place, you won't need these props anymore. The body won't rock on the waist clamp, nor will it lose shape from the weight of the clamps or the clamping process. PRACTICE gluing the top in place by dry-clamping it in the order of the steps numbered below. After doing a dry run for practice, we suggest that you remove the clamps — and do it again! It pays to be able to move quickly and surely when glue is applied.

1. After aligning the centerlines and the body length pencil lines at the neck block and tailblock, first apply two clamps with protective cauls at the neck block end. If you trimmed the neck and tailblock overhangs earlier, align both ends until flush.
2. Begin installing spool clamps at the neck block, using four clamps on each side up to the waist clamp. By gluing the neck block and shoulder area first, the angle of the "neck set" won't be affected if you need to pull or push the tailblock to the 20" mark.
3. Align the sides at the tailblock end with the body length mark, and clamp as you did the neck block.
4. Start installing spool clamps at the tailblock; use seven on each side up to the waist clamp.
5. Remove the waist clamp and install final spool clamps there (**pictured**).

Mark the spool clamps from 1 through 12 on each side, remove them, and lay them out in order for quick reclamping. Apply glue to the kerfed linings, align the soundboard and repeat the clamping process.



KIT TIP: Spool clamps

It's helpful to number the spool clamps during the dry run so they can quickly be reapplied during the gluing process. Spool clamps can be made using 8" all thread rods, wing nuts, drilled wooden spools and cork or leather lining pads. They're also available in our catalog.

Back bracing and fitting

Installing the back bracing

Choose the less attractive side of the joined guitar back as the inside surface, and transfer the pattern for the back braces from the Dreadnought Forward X Bracing plan to their locations. Place the four braces in position with their curved surfaces contacting the back, and notice their more extreme curvature (a 20-foot radius). Unlike the top gluing setup, a flat surface is not used as a gluing caul for the back braces. Instead, make a radiused outer gluing caul by tracing the outer curve of the longest back brace onto a 20" piece of scrap 2" x 4" wood (**illustrated**). Saw and sand it to shape. You can make four cauls if you want to glue all the back braces simultaneously.

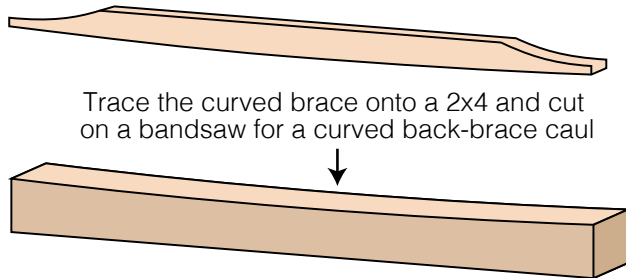

After applying glue to a brace, place the caul on the outer side and clamp the caul and the brace ends first (spring clamps are useful for this). Add two cam clamps to reach the center of the brace.

When all the back braces are installed, trim the spruce center strips into five pieces of accurate length to cover the center seam between the back braces. Glue and clamp the center strips into place and allow to dry before unclamping.

As was done with the soundboard braces, follow the taper and shape of the pre-machined back braces and chisel the ends of each brace to .100" high at the points where they will notch into the kerfed linings.

KIT TIP: Back brace caul

A notched gluing caul, made from 20" x 3/4" x 1- 1/2" scrap wood or plywood (**pictured**), can be placed to one side of the back's centerline, half the distance



of the spruce center strips. This keeps the reinforcing center strips in a neat, straight line from end to end. Use scrap wood cauls and two cam clamps for uniform pressure on each spruce strip. Avoid glue squeeze-out that might stick to the notched caul!

Fitting the back to the sides

If you haven't yet leveled the back kerfed linings, do so now. Use the 5° wedged sanding board.

When correctly installed, the guitar's back will have an arch, with curvature both longitudinally and laterally, and will have a slight overhang of about 1/8" around the outside. Double check that the outside distance of the sides from the neck block to the tailblock measures the correct 20" body length. If it doesn't, the lower bout and tailblock end may have "stretched" out of shape a little. This can happen if the assembly sits too long without a top or back, or as a result of high humidity in your work area. The assembly can be pulled into length as the back is glued on.

At the neck block end, trim the back's spruce center strip until it butts up against the inner edge of the neck block. The pencil mark should line up at the front edge of the guitar at the neck block. Be sure the penciled back outline at the tailblock end is also exactly 20" from the neck block mark.

Place the guitar's back assembly onto the rim assembly, align the center seam with the side seams, butt the trimmed

spruce reinforcing strip up against the neck block, and dry clamp lightly. Next, carefully and lightly dry-clamp the tailblock end of the back, making sure that the body length pencil mark aligns with the sides, and that the centerlines match. If the sides at the tailblock don't align with the body length pencil mark on the back, gently push the sides and tailblock slightly until the body length mark meets the sides, and lightly dry-clamp. You may find it easier to have a friend help in case you need to manipulate the neck block and tailblock into shape.

Use a white pencil to mark the positions of the ends of the back braces on the sides. File .100"-deep notches in the kerfed linings and the sides to accept the braces, as you did for the guitar top. Now, chisel the spruce center strip so it butts against the tailblock.

When the back assembly fits correctly, cut the cardboard inner mold into pieces with a sharp knife and remove them.

Installing the back

In the waist area of the soundboard, trim away the 1/8" overhang so the waist clamp will fit. Install the waist clamp from the front of the guitar to hold the sides in shape while gluing the back.

Clean up the inside surfaces of the body to remove dust and glue. Dry-clamp the back into place with spool clamps and cam-clamps or C-clamps, as you did for the soundboard. Check and correct the fit if necessary, according to the centerline and the body length marks. Unclamp, apply Titebond to the kerfed linings and reclamp, starting at the neck block. Follow the same clamping order as you did with the top (**pictured**). Let the glue dry overnight.



StewMac's tool recommendation

StewMac Spool Clamps Item #3715

Assembly clamps with a different twist! The simple spool clamp for soundboard and back assembly, made faster and easier with a hardwood handle. (After all, glue won't wait forever while you fiddle with wing nuts.)

Routing and binding

Trimming the top and back overhang

With a saw, chisel and file, remove the section of soundboard that covers the top of the neck joint cavity, and smooth the edges. Routing for the body bindings is easier if the excess top and back overhang is removed first. You'll be able to see

the router bit better, and there's less chance of wood tearout. You can trim off the overhang with a sharp knife and a file, or get in close with those hand tools and flush-cut with a ball-bearing router bit.

Routing for the plastic body bindings

Use a small straightedge to examine where the top and back meet the sides. Look for dips, rises or other imperfections. Scrape and sand the wood flat and smooth for at least 1" on the sides and 2" or 3" on the top and back. This will provide accurate surfaces for your router base and ball-bearing cutter. Be particularly careful in sanding and smoothing this area because imperfections will result in an uneven binding channel.

Regardless of the tool you use to rout the body for binding, a straight-cut router bit must be used to produce a right-angle ledge. You can use a Dremel router with our adjustable binding router attachment and 5/16" bit, if you approach the final size slowly. We used a more powerful laminate router of manageable size and a relatively small-diameter baseplate. The baseplate didn't extend far enough out on the arched guitar back to tip it out of proper alignment with the sides. We also used our ball-bearing Binding Router Bit and bearings.

To keep wood dust and chips out of the shop in our video, we moved outside and rested the guitar body on the open top of a rectangular plastic garbage can. Hold the body securely with your elbows as you rout. For more stability, secure the guitar body to your plywood work surface by screwing several close-fitting wood blocks onto the board around the body. Thin strips of veneer or heavy cardboard can be lightly wedged between the blocks and the body to hold it fast. You can also use the waist clamp fastened to your workbench for most of the routing, and remove it to rout the waist of the body.

Wood tear-out is always possible when routing, but especially with long-grain, quartersawn tonewoods. Therefore, start with four "climb cuts," so-called because the router is "climbing," or being pulled along as the bit grabs the wood.



Begin at the centers of the top and lower bouts on both the treble and bass sides (**illustrated**), with the router base moving in the direction of the rotating cutter (clockwise). Rout up to the areas indicated by the arrows. When all four climb cuts have been made, you can move the router in the opposite direction (counterclockwise) cutting into the wood rather than climbing (**illustrated**). Make one continuous pass around the guitar. When you reach the areas that were already climb cut, the router will pass without tear-out.

Use a dial caliper to set your router cutting dimensions, and make a few test cuts on scrap wood until you get the proper height. Test-fit your bindings on these practice cuts (**pictured**). If you can, test on scrap that is curved similar to the shapes you will be routing on the guitar.



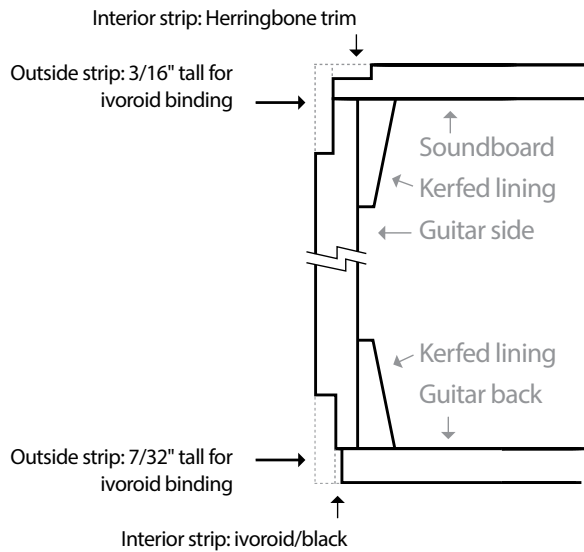

The first pass is for the interior strips and is made with the appropriate bearing on the cutter bit. The router bit should be set to cut a shallow ledge and a width to accommodate both the interior strip and the outside ivoroid binding. Make practice cuts on scrap wood, check the fit of the trim strips before routing the actual channels. Once starting the routing on the guitar body, check the fit before going very far to be sure both the depth and the width are correct.

The second pass is for cutting the recess for the outside ivoroid binding. For a traditional appearance, rout this slot no taller than $\frac{3}{16}$ ". Again test this cut on a piece of scrap wood, preferably the same piece where you adjusted the first cut. When the cut is adjusted, dry fit both pieces of binding in the stepped slot to be sure they will both fit. The outside strip of binding will extend slightly above the level of the top to be scraped flush when the glue dries.

After routing the top and back, use a file to smooth out any irregularities in the routed channels, especially around the back of the body.

KIT TIP: Router base compensation

Here's a tip for routing the top and back more accurately: The arch of the top, and especially the back, will change the router alignment. Coupled with any irregularities in the wood, this can cause the routed channel to be too deep or too shallow. You can avoid this by wrapping several layers of $\frac{1}{4}$ "-wide masking tape around the ball-bearing for the first cut, and peeling them off gradually for successive cuts. Measure the depth of cut for each pass until it's correct. Likewise, lower the router bit gradually in several passes to reach the final correct channel height.

The significant 5° back arch makes it difficult to keep the router square to the sides for an accurate vertical cut. Make a 5° wedge the same size as your router baseplate and attach it to the baseplate with double-stick tape (**illustrated**). You'll use this

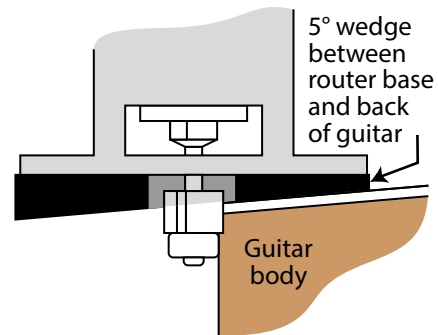

wedge for routing from the neck block area all the way to the last brace in the lower bout. You'll stop there, remove the wedge, readjust the height of the bit, and finish the cut to the center of the tailblock before stopping again. This will be repeated on the opposite side of the body. With the router unplugged, practice with the wedge and try to keep the router bit square to the sides. It won't be perfectly square everywhere at all times, but should give excellent results.

You'll need to swing out as you reach the first shoulder, swing in as you near the waist, and swing out as you approach the last brace. This isn't easy if you're also trying to make the climb cuts to avoid tear-out. If you ignore the climb cuts and rout the entire back in a counterclockwise direction you'll have more control. In that case, lower the bit in several passes, and use tape on the ball-bearing to make shallower cuts in stages, to eliminate tear-out.

Installing the end trim

Separate end trim from the ivoroid blank using a razor knife (set the heel cap aside for later). Clean up the cut edges with a file or block with 120-grit sandpaper. Be careful to keep the pre-routed shape, lines straight, and edges square.

With the tailblock facing up, secure the body using the waist clamp screwed to your workbench.

Cutting the channel for the end trim: Center the tapered plastic end trim at the end seam of the guitar, about midway from top to bottom, with the wide end toward the soundboard (see the blueprint, upper left). Outline the end trim onto the guitar body. Then measure out 1/32" from those lines to allow for the additional thickness of the purfling on each side. Score this line with sharp razor knife and straightedge, gradually deepening it with several passes.



Remove the wood between the scored lines with a router or chisel, just deep enough for the thickness of the end trim.

Fitting the end trim and purfling: Cut a 6" piece off of each of the two supplied .040" ivoroid/black purfling strips. Check the fit of the end trim with the purfling on each side (the black line should be on the inside) in the channel, slide until the wedge tightens the pieces (**pictured**).

When the fit is perfect, glue the purfling and end trim in place with Bind-ALL. Clamping should not be necessary. After 24 hours drying time, trim the ends to match the routed binding ledges. Level the end trim flush with the guitar sides, using a sharp scraper blade tool.

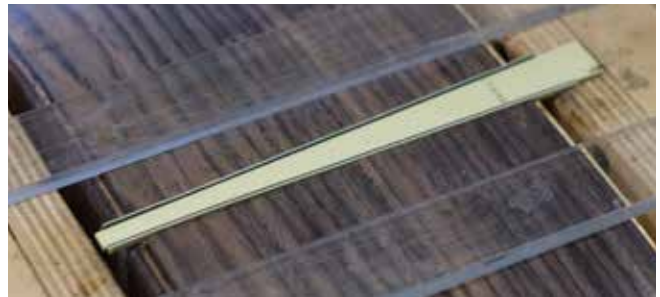

In these pictures a routing template was used, but it's not necessary to get great results.

Installing the bindings

We prefer our high-tack binding tape to hold the bindings, but you can also use cloth tape or long rubber bands. Before gluing, prepare by tearing many pieces of tape in 2" lengths.

Binding the top: apply Bind-ALL glue to a section of the routed soundboard channels, from about six inches to one-quarter of the distance around the guitar from the tailblock seam (**pictured**). Set the herringbone trim in place; the pattern should point toward the neck block.

Apply a little more Bind-All on its edge, and set the ivoroid binding strip against it in the outer channel. You can glue both strips simultaneously. Secure them tightly with tape (**pictured**) and press the herringbone trim down firmly. Repeat the procedure to complete one side of the soundboard, and allow 6-8 hours drying time before binding the other side.

Remove the tape by warming it with a heat gun (or a hair dryer) held at least 6-8 inches away. Pull the tape off at a 45° angle (**pictured**). When warmed, the tape will lift easily without pulling out wood fibers.



Binding the back: glue the thin ivoroid/black purfling first (ivoroid side in, black faces out) followed by the thick ivoroid binding. The binding joints at the neck block and tailblock must be trimmed for a close fit (**pictured**). Bind-ALL is a solvent based glue, so it will melt the joints together. Allow 6-8 hours drying time before removing the tape.

It's best to wait at least two days before scraping the bindings flush to the wood, because the plastic will shrink slightly as the glue solvent evaporates. Use a scraper blade to smooth the bindings flush to the guitar's sides, back and top. Scrape in the direction of the wood grain, and avoid digging into the wood. Practice on scrap if possible.



Opening the dovetail joint

Now you can remove the side wood covering the neck joint opening in the neck block. With a sharp stiff knife or a saw, score through the sides until the waste wood can be snapped off up to the scored line (**pictured**). A Dremel can also be used to remove this wood as shown. Follow with a sharp chisel and a file to smooth the sides flush to the inner walls of the dovetail (**pictured**).

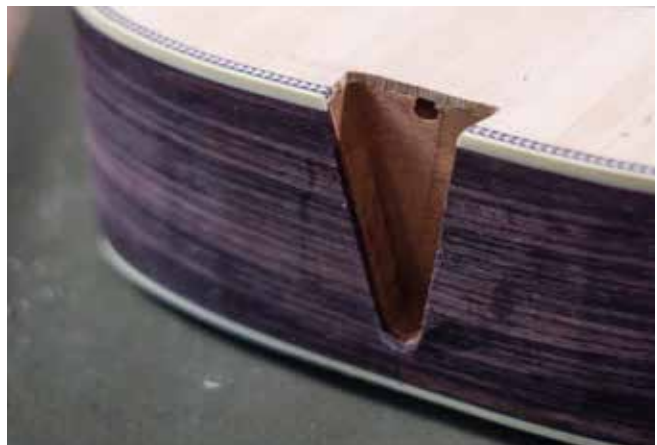

Fit and fill the truss rod channel

Fitting the truss rod

The neck block has been drilled to allow access to the truss rod's adjusting nut, but the rod is not designed to extend beyond the neck (**pictured**). This allows for neck removal, should it ever become necessary (this is normal on a dovetail neck reset).

The neck channel at the heel needs to be enlarged to accept the truss rod's adjustment nut. Mark the position of the adjustment nut on the face of the tenon, nut side down. Mark the length of the adjustment nut on a 17/64" drill bit with masking tape to act as a depth stop. Run the bit in reverse to start the hole, and then drill open the truss rod channel to accept the nut.

Now slide the Hot Rod Truss Rod into the neck channel from the heel end, with the adjustment nut down. Set the neck into the neck block. Using a 4mm Allen wrench, check for sufficient access to the adjusting nut. Adjust the hole size if required.

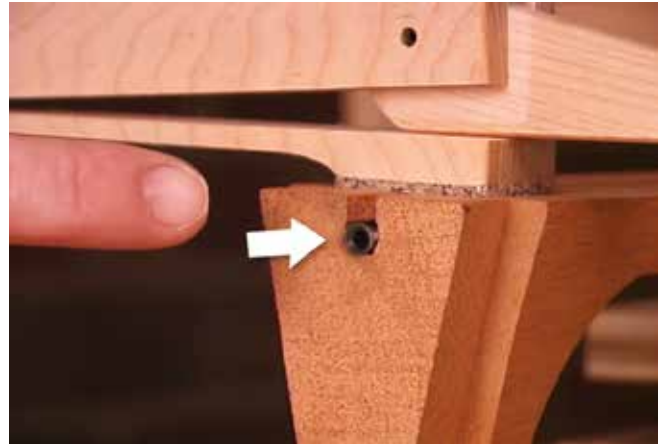

Fill the channel

Before the peghead overlay can be added, the space between the truss rod and the peghead face needs to be filled with the included channel filler plug.

Dry-fit the plug, abutting the end of the truss rod. The truss rod adjustment nut should be flush with the end of the neck joint tenon (**illustrated**). Glue only the filler plug into the channel. Once the glue dries, trim off the excess so the filler plug is flush with the peghead.

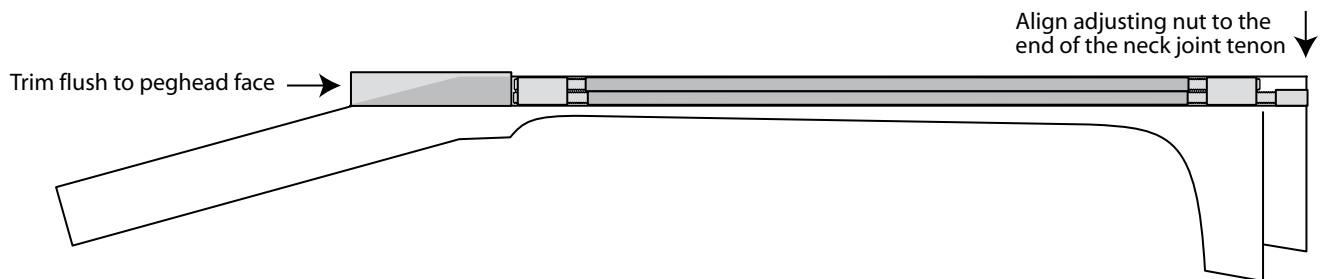

Peghead shaping and drilling

Peghead overlay

Align the nut end of the fretboard with the break angle, where the peghead begins. Pencil a mark on the peghead face 3/16" from the nut line. Align the peghead overlay with this mark. This will leave some extra overlay wood to be trimmed away when the nut is fitted later.

Using Titebond, glue and clamp the rosewood overlay veneer, grain running lengthwise, to the face of the peghead aligning it with the pencil mark. Use at least four C-clamps with protective wooden cauls, and prepare a V-shaped caul to fit around the "diamond" contour below the nut area (**pictured**). Unclamp when dry, and trim the overlay flush to the sides of the peghead with a knife and file.



Shape the peghead

You can round the upper corners of the peghead according to the blueprint, design your own shape, or leave them squared in the vintage style. Shape the bottom later, when you work on rounding the neck.

Enlarge the pegholes to fit your tuner bushings. Depending on your tuners, you could use a standard peghole reamer (**pictured**), or our Peghead Bushing Reamer (if you are using Waverly tuners, we recommend #2062). Ream until the collar of the bushing is about 1/32" from the face of the peghead; at this point the bushing should press in with a snug but not too tight fit.



KIT TIP: Drilling tuner holes

As an alternate to reaming, you can drill out the bushing hole. Place a smooth 1/4" diameter steel pin in the chuck of your drill press. (You can use a drill bit, but there is no drilling. This is for alignment only). Lower it until the pin enters one of the predrilled peg holes. Clamp the peghead in that position. Raise and lower the pin and check for accurate positioning by rotating the chuck to see if the location is right all around. Reposition if needed. Without moving the peghead, change to the proper size drill bit to allow the bushing to be pressed in gently (practice on scrap wood). This secondary hole should be drilled only to the depth of the bushing. Relocate and clamp the peghead for each of the remaining holes.

Press in the tuner bushings and set the tuners in place. Line up the baseplates of the tuners with the edges of the peghead, and centerpunch the mounting screw holes. Use a small drill bit of the appropriate size for the screws, with masking tape as a depth-stop on the bit. Install the mounting screws, and then remove the tuners and the bushings.

Later, during finishing, the mounting screw holes will fill over but will open easily with a light drilling. By installing the tuners at this stage you'll lessen the chance of chipping the peghead finish.

Holes for non-tapered press-in bushings may require a countersunk hole, or careful filing to enlarge the reamed tapered hole. After you have fit the first bushing, use the peghole as a reference and wrap tape around the reamer as a depth stop for the remaining holes.

Making a fretboard

Trimming the fretboard

The fretboard needs to be tapered, starting at the nut slot. The nut supplied is preshaped to 1-3/4" width.

On the slotted side of the fretboard, measure and mark the center of the nut slot, then measure 7/8" (half of 1-3/4") out from the center mark on each side.

Then at the 14th fret, measure and mark the center, then 1-3/32" (half of 2-3/16") out from the center mark on each side at the 14th fret.

Using a straight edge draw a line from the nut mark to the 14th fret mark and let the line continue on to the end of the fretboard. Do this on each side of the fretboard.

Tracing onto the curved (slotted) side of the fretboard allows you to cut the board on a bandsaw with the flat side down on the saw table. The fretboard can also be cut with a coping saw or a hand plane. Cut the sides along your pencil lines, leaving the lines visible. With a plane or sanding block you can remove saw marks and smooth the edges, removing the pencil lines.

True the cut edges of the fretboard with a "shooting block" using 80-grit sandpaper, followed by 120-grit. Clamp the fretboard flat-side down onto a piece of wood about 1/4" thick and as wide and long as the fretboard — this is a shim

to lift it off the work surface for sanding. Clamp the fretboard so one side hangs over the edge of the shim, and sand it with the shooting block. **SAVE YOUR SAWDUST!** The fine wood dust can be mixed with super glue and used to fill fret ends later.

KIT TIP: Shooting block



A shooting block is a long, square-edged sanding block for creating smooth, straight surfaces. We used a carpenter's level and fastened the sandpaper to it with double-stick tape (**pictured**).

Inlaying the fretboard

Mark the location of the fret markers on the fretboard using the centerline that you made earlier.

The large diamonds will be inlaid at the 5th fret and 9th fret, the smaller squares will be inlaid at the 7th fret, 12th fret, and one at the 15th fret (two squares are inlaid at the 7th and 12th frets) (**pictured**).

For single fret marker positions, make marks on the centerline midway between the appropriate frets and centerpunch them for drilling. For fret locations inlaid with two markers, make a line at a right angle to the centerline, midway between the frets, and then measure to each side of center to make the centerpunch marks. Hold each inlay firmly in place and trace around it with a sharp scribe or white pencil, use a Dremel or other small router to make the recessed pockets for the inlays. A 1/32" router bit will work best.

Use brad-point drill bits if possible, and always start the drill in reverse to get the hole started on center. Measure the thickness of your inlays, and don't deeper than the thickness of your inlay. The goal is to keep the inlay just proud of the fretboard, allowing it to level perfectly with the fretboard

without being below the fretboard surface.

CAUTION: Unless you clamp the work and use a stationary drill press with a depth-stop, it's easy to drill too deep, tear out the wood, or drill completely through the fretboard by mistake. Be careful, and **practice on scrap**!

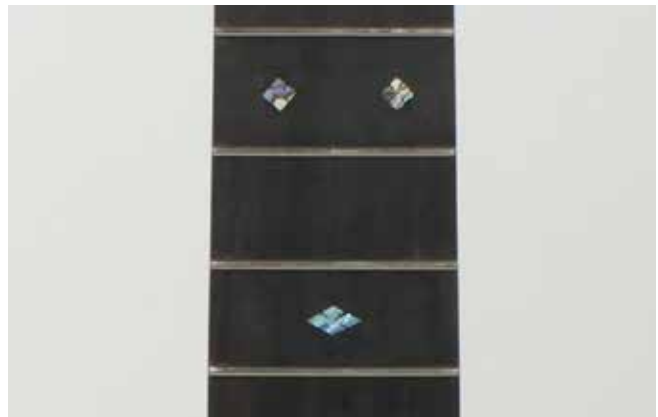

Use just a touch of super glue or black epoxy to permanently set your inlays. The inlays are a tight fit, so you may need to press them flush to the surface of the fretboard using a hard, flat object. Use wax paper placed between the them—you don't want to have the object glued to your fingerboard if there is any glue squeeze-out. After you press the inlays flush

in the center of the fretboard, they will be raised slightly at the edges, since the fretboard is radiused. Use a smooth mill file to level the inlays, and then smooth the board from end to end using a hardwood block wrapped with 220-grit Fre-Cut (open-coat) sandpaper. Try not change the radius of the fretboard, however.

Installing the fretboard side dots

Clamp the fretboard to a board, rest that board on its side, and clamp this assembly to your benchtop with the bass side of the fretboard facing up. Measure midway between the appropriate fret slots, center carefully on the fretboard edge, and lightly centerpunch for the side dot position marker holes. Two evenly-spaced dots will be installed at the

12th fret. Drill all these holes with a 1/16" bit. One at a time, touch a drop of medium-viscosity super glue to each hole and insert the end of the plastic side dot rod. Snip it close to flush. Level the dots with a smooth mill file (or the 120-grit edge of the carpenter's level used earlier). Use a light touch in sanding so you don't alter the fretboard edge.

Installing the frets

With a flat block (or a 16" radius block if available), stroke the fretboard lengthwise a few times, uniformly with 220-grit sandpaper, as a final smoothing to prepare for fretting.

Do your fretting on a flat hard surface (we used a slab of 1-1/4" thick marble). The fretwire is curved, and must be cut to length for each fret slot, but leave 1/8" overhang on each side. Keep the cut frets arranged in order.

KIT TIP: Gluing the frets

There's no need to use glue on a new fretboard, but the choice is yours. Glue keeps the frets tight and lubricates the slot for possibly easier fret installation, but also may produce an occasional loose fret end.

Set the first fret in place and hold it so that it can't tip, to prevent wood chipping (**pictured**). Seat the two fret ends with one sharp hammer blow each, then hammer back and forth across the fret. Since the fretwire is more curved than the fretboard, the fret straightens as it's hammered in. This causes the barbs on the fret tang to move sideways in the slot, tightening the fit. Avoid tipping the hammer face so that its edge hits the fret, or you'll dent the wire. Hammer from your wrist, in short crisp blows (**pictured**). A scrap piece of fretboard has been included with your kit, as well as enough fretwire to practice fretting. Measure out the frets you will actually use on your fretboard, then use the leftover fretwire to test your skills on the scrap.

As you progress down the fretboard, the compression of the fret tangs will cause the fretboard to backbow a little, so be sure to hold the fretboard flat as you hammer. Install the wire up to the 14th fret and stop. The remaining frets, in



the fretboard extension over the body, will be installed later, after the neck is "dry-fitted" to the body. We do this because the fretboard extension will curve slightly from fret compression, making sighting and fitting the neck more difficult.

Test the tightness of a couple of fret ends by prying up a little with your fingernail. The fret ends should be seated tightly (**pictured**). To ensure this, you can rest the fretboard on edge and run a bead of water-thin super glue into the slot. Let it run through the slot and out the other side. Loose frets can be clamped using a 16"-radius sanding block as a caul before running the super glue into the slot. Use wax paper between the caul and the fretboard.



With flush-ground fret cutters, nip the fret ends close to the edge of the fretboard (don't dig into the wood). Use a smooth mill file, or sandpaper on the carpenter's level, to bring the fret ends flush. Then, holding the fretboard flat against your work surface, use the mill file to bevel the fret ends at about 60°. Work slowly — you can always add more bevel, but you can't put the metal back. Lightly round over the sharp upper edges of the fretboard so they'll feel comfortable to your hand. Our Fret Beveling File makes this job quick and uniform.

Installing the fretboard

Gluing cauls can be made to match the radius and length of the fretboard, and notched to rest over the frets. However, a simple method that works well for gluing and aligning the fretboard is to wrap it onto the neck with a large rubber band. You may need two rubber bands, but one worked for us.

With the truss rod installed, clamp the peghead into a swivel-jawed repair vise or to your benchtop, with the neck overhanging. Cut a broomstick or a scrap of wood as a prop, and wedge it under the neck heel with just enough force to push the neck into a slight upbow, or "relief," of about .012" or .015", as noted using a straightedge. This will be approximately the same amount as the slight backbow the fretboard probably took on during fretting. The two curves, upbow and backbow, will cancel each other as the fretboard is glued on, resulting in a straight neck and an unadjusted truss rod.

Lightly spread Titebond glue evenly on the neck surface. Leave the edges of the truss rod channel almost dry, the glue squeeze-out will spread right up to the edge of the channel. Be careful not to get glue in the channel. Set the fretboard on the glue surface, and align the nut end with the nut line on



the neck. Tie the rubber band at the nut end, and start wrapping (**pictured**). The fretboard will align itself as you wrap, and can be easily moved if one edge is off-center. Stretch the rubber band tightly as you wrap toward the neck heel, go around the neck joint and the heel, and then wrap back to the nut. Even with a light glue application, you'll probably get a lot of glue squeeze-out. Wipe off excess glue and let the neck dry overnight.



StewMac's tool recommendation **Essential Fretting Tool Kit** Item #3125

Our fretting experts compiled this kit of tools you'll need for the fundamentals of fret work: installation, removal and dressing. Our photo-illustrated book, *Fretwork Step By Step*, is the most complete work ever published on the subject, and it is included **FREE** to get you started!

Neck shaping and fitting

Shaping the neck

When the glue is dry, remove the rubber bands. The neck must be trimmed to meet the edges of the fretboard, without removing any of the fretboard edges or filing deep marks into them.

To complete the peghead “diamond” a little carving is necessary. Visualize the back of the neck shape continuing right up to an imaginary line at the end of the fretboard. A chisel or a file is best for establishing these lines, as well as for carving the diamond into a more delicate shape (**pictured**). Follow with a half-round bastard file or a smooth mill file (**pictured**). Finish with 150, then 220-grit sandpaper and a couple of small sanding blocks for smoothing. Always switch to the next tool or sanding grit just before you think you need it, to avoid overdoing it with any one tool.

KIT TIP: Neck sizes

Although the neck has been machined to reasonably close tolerances, plenty of extra wood has been left to accommodate different neck sizes and shapes. You can make tracings from the blueprint, and cut out neck cross-section templates for checking the shape of the back of the neck if you like. We penciled the entire backside of the neck and used our files at a slight angle along the length of the neck (**pictured**). When the pencil marks were removed, or left evenly and slightly below the grain of the mahogany, we switched to finer grit sandpaper.

Using a rasp, followed by a half-round bastard file, shape the neck’s heel. When the heel is close to the final shape, stop. Finalize the shape later, when you add the heel cap.

Installing the nut

The guitar peghead tilts back 15° from the fretboard surface. This angle must be filed and sanded onto the bottom of the nut. Leave the top surface of the nut untouched for now.

From a scrap of wood at least 1/2" thick, 2-3" wide, and long enough to clamp to the peghead face, make a “saw fence” by beveling the thin edge at 15° (**pictured**). Hold the nut blank, beveled side down, firmly against the end of the fretboard, butt the saw fence against it on the peghead, and clamp it in place. Remove the nut and use the fence’s 15° edge to guide your razor saw to cut through the peghead veneer. Stop just short of the mahogany! Chisel away the peghead overlay between the sawed line and the fretboard to expose the mahogany, creating a slot for the nut. The nut should fit snugly.

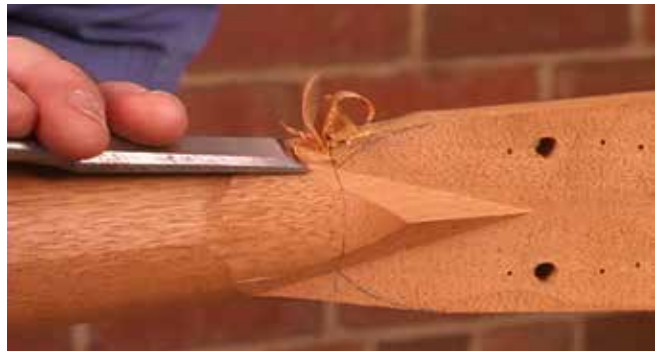

Lightly glue the nut in place with a couple of drops of Titebond in the mahogany slot, and a couple of drops on the end of the fretboard. You can sand the edges of the nut when you final-sand the neck.

Fitting the heel cap

Note: Before attaching the heel cap, set the neck into the body and mark the heel of the neck where the back binding meets the sides, then trim the heel to this height (pictured). Trim the heel cap from the pre-cut ivoroid piece provided. Attach the heel cap trim to the flat bottom of the heel with Bind-ALL, and let it dry thoroughly.

Carefully and gently file and sand the material flush to the wood, and avoid tearing it loose. Now continue final-shaping the heel with your half-round file and sandpapers. The neck should be final-sanded to 220-grit.



Understanding the neck joint

Ideally, the neck block has remained square to the side assembly. The neck will meet the top at a subtle 1-1/2° angle. When they are square, a minimum of hand-fitting is needed to get the proper neck set (the angle of the neck/body joint). However, it's not uncommon to find that some adjustment is needed in setting the neck. Use the following information to adjust the angle of the neck in any direction.

The neck joint is a mortise-and-tenon joint. The tenon is the precision-cut extension on the end of the neck, and the mortise is the neck block recess which fits it. A dovetail joint is glued together using a tenon with angled sides.

KIT TIP: Understanding neck angle geometry

Here's the way to determine how much wood must be removed from the cheeks for the correct neck angle at the bridge. Always remove wood gradually and check your progress frequently. A little adjustment goes a long way! Our example measurements below are based on the scale length of this guitar: 25.4 inches.

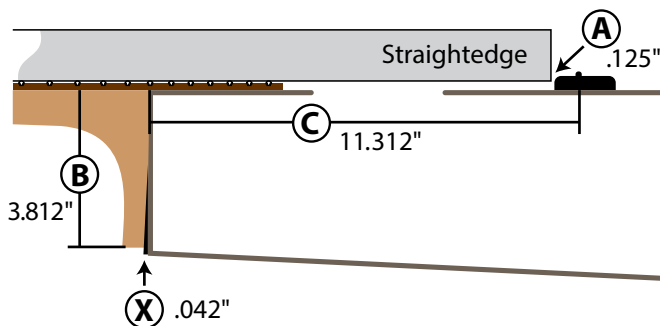

The measurement we want is **X** — the amount of wood to remove from the heel to change the neck angle so that a straightedge laid on the frets will be flush with the top of the bridge.

A = How far the straightedge falls below the top of the bridge. In this example: 1/8" (.125").

B = The heel length from the fretboard bottom to the heel cap. In this example: 3-13/16" (3.812").

C = The distance from the neck/body joint to the saddle. In this example, that's at the 14th fret, and **C** = 11-5/16" (11.312").

$$X = A \times B \div C$$

In this case, those numbers are .125" x 3.812" ÷ 11.312" = .042". So in our example **X** = .042" which is between 1/32" and 3/64". This is the amount to remove at the bottom of the heel.

The neck heel sets the neck angle

The neck angle is controlled by the shape of the neck heel as it contacts the sides of the body. It is not determined by the fit of the mortise-and-tenon joint. (In fact, correctly setting the angle on a dovetail neck actually loosens the dovetail joint, which is later re-tightened by using a wooden shim.)

Removing wood from the top or bottom of the neck heel tips the neck forward or back. Removing from either the bass or treble side changes the neck's angle in relation to the center of the bridge.

Fitting the neck to the body

The two roughly triangular surfaces on either side of the tenon are called the "cheeks" of the neck heel. These cheeks are machined flat, but the guitar sides they contact are not flat: the guitar has a slight curvature at the neck block. Most of the handwork in fitting a neck is cutting away the inner part of these cheeks to fit this curvature. Only the outer edges of the heel make contact with the body, and these edges set the neck angle (**illustrated**).

The contact area of the heel is an area about 1/8" to 3/16" wide around the outer edges of the bass side, treble side, and bottom of the cheeks. Mark this area on the heel with a pencil. Using a sharp chisel, remove wood from the remaining inner area up to the tenon (**pictured**).

After under-cutting the cheeks this way, you should have a neck fit that is very close. Still, you may need to remove a little wood from the outer contact edges to adjust the neck alignment. Removing wood from the upper part of the neck cheek edges will raise the neck (decrease the angle), removing from the bottom will lower it (increase the angle). Taking wood from either side will move the neck in that direction.

It's important to note that removing wood from a dovetail neck will move the neck toward the bridge slightly. This will loosen the dovetail joint, and introduce a slight side-to-side play. You want the neck to be in the same position each time you check it for fit, so firmly hold the dovetail against either the bass or treble wall of the dovetail socket. It doesn't matter which side, as long as you always use the same side during fitting.

Tape the bridge to the soundboard (guitar top) using low tack draftsman's tape. Center the bridge on the soundboard so that it is square to the centerline. The center of the bridge saddle should be 11-3/8" from the neck end of the guitar. (Since the neck block has an opening for the neck joint, you can measure from the center by laying a flat object across this opening.)

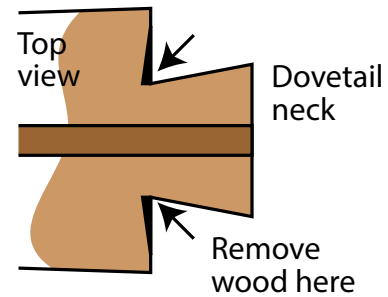

Neck adjustment: side-to-side

The first area that may need to have a small amount of wood removed is the treble or bass cheek. Wood removed here controls the “side-to-side” alignment of the neck to the centerline. If the neck is misaligned side-to-side, one of the outside E-strings will be too close to the edge of the fretboard. A tiny amount of wood is all it takes to make an adjustment here. Remove this bit of wood uniformly across the contact area on one cheek to tip the neck in the proper direction (this won’t change the neck angle when viewed from the side of the body). Use a straightedge laid against both the treble and bass sides of the fretboard to check the alignment: it should extend out the same distance from center on either side at the bridge (**pictured**).

You may not need to make an adjustment at this stage. If the neck is off-center by only 1/32" or less, don’t try to correct it. Remember that a tiny bit of wood removal makes a big difference in the neck’s relationship to the centerline!

The top edge of the cheeks is the pivot point between the neck and body. This controls the neck angle as viewed from

the side. To check the angle, lay a straightedge on the frets so that it extends to the bridge. Ideally, it will just graze the top of the bridge (without a saddle). If it falls above or below the top of the bridge by more than 1/32", an adjustment is needed at the heel.



Neck adjustment: tilt the neck back

The most common adjustment is removing wood from the bottom of the heel cheeks. Removing wood from the bottom of the heel on both the treble and bass sides equally will tip the neck back (**illustrated**). Remove the wood in a wedge shape which tapers to zero at the top edge of the cheeks.

Use the formula in “Understanding neck angle geometry” to determine how much wood to remove. With a sharp pencil and a straightedge, mark the area to be chiseled away in a straight line from the bottom of the heel to the zero point at the top. Continue this line across the heel cap and up the opposite side. These lines may be tricky to draw, because they must taper away to nothing — to the zero point at the top of the heel.

With a sharp chisel, remove about half of the measured amount of wood. Don’t overdo it: set the neck into the body and check the fit. You’ll finish the shaping with sandpaper — preferably 100-grit emery cloth (cloth-backed sandpaper). Loosen the neck joint and slide a strip of this sandpaper or emery cloth between the heel cheek and the body with the abrasive side facing the cheek. Slide the strip almost — but not quite — to the top edge of the heel (this top edge should be left intact). Be sure to angle down to keep the heel cap in contact with the sides. Hold the heel against the guitar body and pull the strip out toward you (**pictured**). This removes a little bit of wood while conforming to the shape of the guitar body. Shake the sawdust off the sanding strip and repeat the procedure on the opposite cheek. Sand equally from side

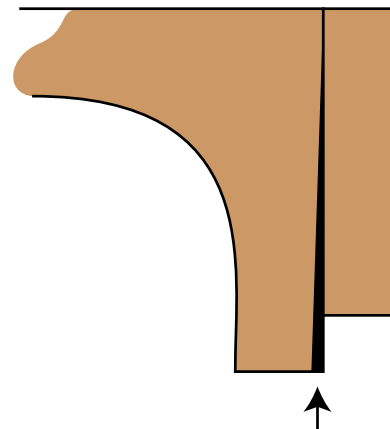

Removing wood at the bottom edge tips the neck back



to side. If you need to remove a lot of wood, make two or three passes before changing to the other cheek. The fit will change rapidly, so check your progress frequently.

A small ledge of unsanded wood will remain on the bottom of the heel between the sanded cheeks. Either “pull-sand” it with the strip, or use a sharp chisel to remove it.

Neck adjustment: tilt the neck up

Wood is seldom removed from the top of the heel, but if the neck block was mistakenly tipped forward when glued in place, the neck may be “overset” too far away from the body. In this case, the straightedge laid on the fretboard will extend above the bridge. Removing wood from the top of the heel on both the treble and bass sides equally will bring the neck up so the straightedge comes down to the top of the bridge (**pictured**).

Use the formula in “Understanding neck angle geometry” to determine how much wood to remove. With a sharp pencil and a straightedge, mark the area to be chiseled away in a straight line from the top of the heel to the zero point at the bottom. Repeat this line on the opposite side.

The sandpaper strip described above won’t work here because the fretboard is in the way, so you’ll need to use a sharp chisel to remove the long taper of wood on each

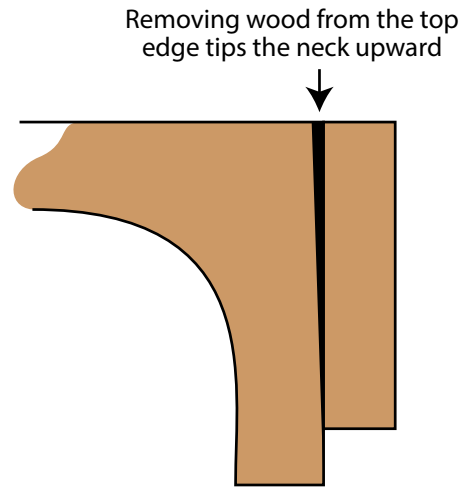

cheek. Cut in the direction of the top edges. A final light, downward pull of the sandpaper strip will clean up any marks left by the chisel.

Tightening the dovetail joint

When the cheeks fit accurately and look good on both sides, fit a piece of the supplied shim stock into the loose side of the dovetail. Hold the dovetail neck into the mortise and rock the heel. It will most likely be looser at either the top or bottom of the cheeks. File the shim stock in a wedge-shape to fill

the gap. You may need to make more than one shim to get it right. When the shim is fit properly. The dovetail will pull the cheeks in tightly and the neck will stay in the body on its own.

Installing the last frets

Now that the neck is fitted, it’s time to install the remaining frets in the fretboard extension. On your workboard, butt the tenon against the edge of something sturdy and tall enough to meet the underside of the fretboard extension (we used a brick). The entire neck and fretboard must be supported when you hammer to avoid breaking the fretboard extension. Nip the fret ends, file them flush, and bevel them as you did earlier; keep the extension supported here, too.



Finishing

Introduction to finishing and materials

We recommend finishing the neck and body separately, for a better job of sanding and buffing. When the neck is attached, it's more difficult to fill the grain, sand, and buff around the neck/body joint. Also, lacquer tends to build up in that area, and unsightly air bubbles may become trapped there.

The quality of your finish work is certainly important to the appearance of your guitar. A thin "nonprofessional" finish won't necessarily harm the sound of your guitar, however. If the following instructions seem beyond your skills (we assure you they're not), or to be more work than you'd like, you can simply apply a low-gloss "wipe-on" finish by hand, consisting of a couple of coats of waterbase lacquer or freshly mixed shellac. This will seal the wood and protect it from the elements, and you'll be playing your new guitar a lot sooner.

The following instructions, for spraying an aerosol nitrocellulose lacquer finish, are relatively foolproof and don't involve an investment in shop spraying equipment. Aerosol lacquers require no thinner, or course, but it's nice to have thinner around for cleanup. Feel free to apply the finish of your choice, however, according to the manufacturer's directions. If you decide to use spray equipment, always thin nitrocellulose lacquers with nitrocellulose thinner only.

Sanding the body

All the wood surfaces should be fine sanded up to 220-grit using Fre-Cut® paper on a sanding block. Start by sanding the back and sides. Mask the soundboard with brown paper and masking tape, to protect it from the darker wood dust. The sandpaper should be no coarser than 150-grit, and you should switch quickly to 220-grit. Sand in the direction of the grain, not across it. After the first 220-grit sanding, dampen the entire surface lightly with a water-dampened (not soaked!) cloth to raise the grain. Let it dry, and sand again with 220-grit. Blow-off and vacuum the wood dust.

KIT TIP: Aerosol Lacquers

Aerosol lacquers have a tendency to "spit" if the spray tip gets clogged. Wipe the tip clean often. Also, you can clean the tip by turning the can upside down and spraying until the spray stream stops. We recommended doing this each time you are done spraying, to keep the tip clean.

There are many gallons of finishing information in our book *Guitar Finishing Step-By-Step*, and we know of many customers who are glad they studied the book before finishing their first guitar. In brief though, here are some pointers and a finishing schedule to follow.

KIT TIP: Finishing

ALWAYS practice on scrap wood until a finishing method has been perfected. Scraps of wood are included in each kit so you can practice all the finishing steps. If you'd like your guitar to look as good as it sounds and plays, DON'T RUSH!

KIT TIP: Sanding

Always use a backing block or pad when sanding the guitar body. It will help maintain a level surface. On round surfaces, use a flexible rubber backing pad, a thick piece of felt or leather, or fold the sandpaper three or four times to give it firmness with flexibility.

Unmask the top, and sand it just as you did the back and sides. Don't use the same sandpaper you used on the rest of the body. Blow-off and vacuum the dust from the open grain pores.



StewMac's tool recommendation
ColorTone Aerosol Finishing Kit Item #1850

Even if you're a beginner, you can achieve beautiful results you'll be proud to show off. You'll get professional guidance from the best instruction book available too—included FREE with the kit.

Filling the fret ends

Before sanding the neck, “drop-fill” the small fret slot spaces under the ends of the frets. Blend super glue with some fine wood dust, reserved from when you shaped the fingerboard. We brushed super glue accelerator on the openings first, waited five minutes, then used a toothpick to apply the super glue mixture. After thirty minutes we added accelerator again, and filed the small mounds of glue flush before sanding the neck **(pictured)**. If you don’t fill the ends of the fret slots, holes will remain which the lacquer finish won’t fill.



Sanding the neck

The neck needs extra sanding and grain raising in the end-grain areas of the heel, and the “ears” and the end of the peghead. Sand up to 320-grit, dampening to raise the grain. Do this several times, so the endgrain pores will absorb stain more uniformly for a better appearance.

Finish the wood preparation by wiping the neck and body with a rag, dampened (not soaked) with naphtha, to degrease all the surfaces to be finished. Handle them with clean gloves from now on.

Spray handles and hangers

You can add a spraying handle to a dovetail neck by installing one or two small drywall screws in the butt-end of the dovetail tenon. Or, as an alternative, simply hold the neck at the center, spray the peghead, the heel, and a good portion of the neck up to where you are holding it. Loop an S-shaped wire hanger through a tuner hole and hang the neck for spraying the center area. You can also rest the neck fretboard- down on a riser block and spray it in the horizontal position.

To spray the body, you can install a handle to the neck block with a couple of small drywall screws **(pictured)**.

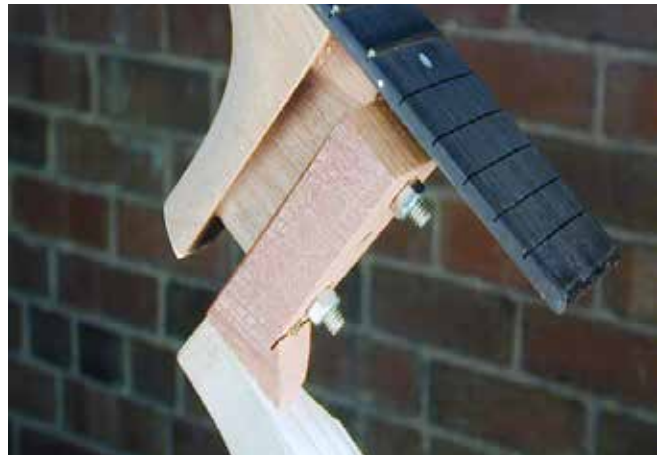

Masking the neck and body

Apply masking tape to cover the areas that won’t be stained or finished. This includes the fretboard playing surface, the sides of the fretboard (to be unmasked after staining), the nut, the dovetail gluing surfaces on the neck and body, and the underside of the fretboard extension.

Mask the interior of the guitar by stuffing newspaper into the body, being sure to tuck it completely into the soundhole.

For a more professional seal, prepare a 4-5/16" diameter cardboard disk, hinged in the middle with tape, and insert it into the soundhole. Hold it in place against the inside edge of the soundhole with an inflated rubber balloon.

Mask the soundboard of the body if staining the back and sides.

Staining

Wear plastic gloves when handling stains! Only the neck should be stained (the back and sides don't require staining).

We recommend our ColorTone water-soluble stain in an equal mix of tobacco brown and red mahogany. Add 25 drops of each color to each ounce of water to produce a warm dark stain. For a lighter, redder color, you can use only the red mahogany at 50 drops per ounce of water. Test these stains on sanded scrap mahogany first.

Four ounces of mixed stain is plenty for a neck and body; one ounce is enough for a neck. Pour the stain into a shallow bowl. Wet a soft clean cloth with stain and apply in long uniform strokes in the direction of the wood grain. It shouldn't take more than a minute to stain the neck, nor more than

three minutes to stain the body. Stain the peghead veneer, too — it's easier than trying to mask it.

Let the stain dry. Unmask the sides of the fretboard, sides of the nut, and the soundboard (if the body was stained). Everything else should remain masked.

KIT TIP: Stain or not to stain

You can also use colored grain fillers to slightly color the bare mahogany or rosewood while filling the pores, and skip the stain entirely. Test this on scrap mahogany and see if you like the somewhat lighter appearance.

Applying a washcoat to seal the wood

Wear clean cotton gloves whenever you touch the wood. Lacquer is highly flammable — always work in a dry, well-ventilated area, away from open flames or sparks. Be sure to wear an appropriate respirator while spraying.

Spray one uniform "washcoat" of clear lacquer on the neck

and body. This is a coat that's not so heavy as to cause runs. The washcoat seals the stain or the natural color in the wood, and keeps the upcoming coat of paste filler from producing a smudged look. Sealed in this fashion, only the open pores of the wood accept the filler. Let the neck and body dry overnight.

Filling the wood grain pores

We recommend using a grain filler for leveling the rosewood and mahogany grain pores. Let the filled wood dry overnight after application. Light sanding with 320-grit Fre-Cut® will remove any remaining buildup of filler on the sealed surface. Try to avoid sanding through the washcoat into the stained mahogany. If a sand through does occur, touch up the area with matching stain and wipe off the excess.

Lacquer spraying schedule

Day One: Never apply more than three coats of lacquer per day. Spray an initial light misting or "tack" coat, followed several minutes later by a heavier wet coat. The tack coat gives the wet coat better adherence and lessens the chance of a run or "sag" in the finish. Spray three wet (not runny!) clear coats on the neck and body, an hour between coats, and let them dry overnight.

Day Two: Lightly "scuff-sand" the neck and body with 320-grit Fre-Cut® paper to knock off the high spots in the finish (on flat areas, be sure to use a backing pad on the sandpaper). Sand just enough to "open" the finish; don't try to sand out every shiny spot or sunken area in the lacquer. Clean off all the sanding residue. Now spray the neck and body with three uniform coats of clear lacquer, one hour between coats. You now have SIX coats. Let the guitar dry overnight.

KIT TIP: Running

If you get a "run" in the finish, let the surface dry for 24 hours and level-sand the problem area. If you touch wet lacquer, you'll leave a deep impression which will be much more difficult to fix.

Day Three: Lightly scuff-sand the finish with 320-grit paper again, and clean off all the residue. You can be slightly more aggressive in flattening the sprayed surface now, but be careful on the curves of the neck, and on ANY of the edges of the neck and body (it's easy to sand through the edges). Don't try to sand out all the shiny spots yet. This sanding will release solvent from the finish and help it to cure. Let the finish dry for two more days.

Day Six: Once again, spray three wet clear coats, one hour apart, on the neck and body. The guitar now has NINE coats. Let the finish dry overnight.

Day Seven: Scuff-sand the finish with 320-grit again. This time most of the shiny spots will disappear, leaving a uniformly dull look. Spray three more clear coats, one hour apart. You now have TWELVE coats. Allow overnight drying.

Day Eight: Lightly scuff-sand the finish with 600-grit Fre-Cut® paper, to help the solvent escape. The neck and body should now be left in a warm dry location for TWO WEEKS to let the finish harden and shrink.

Sanding and rubbing-out the finish

Dry-sand the neck and body to a flat, dull sheen with 800-grit Fre-Cut® paper. Clean the residue from the paper often by wiping on a scrap of carpet or a brush.

“Orange-peel” texture caused by lacquer shrinkage as the solvents cure out of the finish should be removed, but don’t oversand. When all the little shiny low spots in the lacquer have been removed, you’re ready to go to the next step.

Wet-sand with 1200-grit micro-finishing paper and water, to bring the finish to a smooth satin surface that’s ready for final polishing. Excess water and residue should be wiped off the finish with a clean dry soft cloth as you work. Rinse the sandpaper in soapy water often, to remove hard specks that can scratch the finish.

KIT TIP: Blushing

Buy a can of aerosol “blush eraser” for lifting the bluish haze which can occur when moisture is trapped in the lacquer finish. Blushing can result from humid conditions, or if the coat is sprayed too heavily.

KIT TIP: Wet sanding

Soak the micro-finishing paper in water overnight before use. It will scratch less, and last longer. Always keep it wet from then on. Using soft cloths, or an electric hand-drill with foam polishing pads, rub-out the fine wet-sanding scratches to a final gloss with medium and fine polishing compounds.

Use a separate pad for each compound. You can follow this with swirl remover if desired. Clean off the residue left by the polishes, remove the remaining masking tape from the neck, and remove the soundhole masking materials from the body.



StewMac’s tool recommendation **Foam Polishing Pads** Item #3414

Your instrument finishes can have a more professional look when you use these fiber-free foam buffing pads. The gentle polishing action helps avoid swirl marks, fine scratches and burn-through, leaving a beautiful mirror-gloss surface.

Final assembly and setup

Prepare for neck installation

Be sure that the gluing surfaces of the neck joint and fretboard extension are free from dirt, finish and buffing residue.

Press the dovetail with the shim on the correct side, into the body. The joint will be a bit tight due to the thickness of the lacquer. If the neck and its shim go all the way down into the neck block, you can ignore the lacquer on the sides around the dovetail opening and glue the neck right over the finish. If they're too tight, file a tiny amount of wood off the shim until the neck seats correctly.

You'll need a 5° tapered and padded wedge to protect the back of the body and to provide a clamping surface, and the shoulder brace caul you made earlier (in "Bridge and shoulder brace clamping cauls" section). Place the caul inside the guitar so the cut out fits over the shoulder brace, with the remaining length of the caul facing towards the neck block. The underside of this caul will be a surface for clamping through the soundhole. You'll also need a clamping caul for the fretboard extension; we made one from a 16"-radius wooden sanding block, and notched to fit over the frets. Clamp the neck into the body (**pictured**), and use a sharp razor knife to cut through the finish around the fretboard extension. Don't cut into the soundboard!

Remove the neck. The lacquer finish on the soundboard inside the scribed line must be removed with a chemical paint stripper. You **MUST** be careful when applying and removing the stripper — don't get it outside the scribed line!

Mask the soundboard to protect the lacquer finish from



accidental splashing. Use low-tack drafting tape to fasten clean paper on the soundboard around the area. Keep the tape away from the line by 1/16" so the stripper won't touch or overlap the tape. Stripper will soften the solvent in the tape's adhesive, which will cause a permanent wrinkle in the new finish.

Apply stripper with a small artist's brush. Allow sufficient time for the stripper to loosen the finish, and then slowly remove small bits of the finish with a 1/2" chisel used as a vertical scraper. Always pull the stripper inward from the edge of the line to the center of the area to be stripped. After each pull, wipe the residue from the chisel with a scrap of paper towel, which should be carefully lifted away from the area for disposal. When all the old finish is removed, wipe the exposed wood carefully with a damp cloth to neutralize the remaining stripper, and let the surface dry.

Install the neck

Apply Titebond glue to the underside of the fretboard extension, the two sides of the dovetail, and if you wish, add a small amount on the interior walls of the neck block dovetail mortise. Be sure glue contacts both sides of the shim, too.

Slide the dovetail neck and the shim in place and apply your

clamps and cauls as you did when "dry-clamping" before stripping the lacquer. Wipe off the excess glue for about five to ten minutes as it squeezes out, using a clean damp cloth.

Remove the clamps after the glue has dried.

Prepare for bridge installation

The bridge was positioned earlier when fitting the neck, and the process will now be repeated. Place an accurate 18" straightedge on the centerline of the fretboard, butted against the nut. Mark on the straightedge the position of the center of the 12th fret. Add an additional 7/64" (toward

the bridge) to this distance and mark this position as well. This is the necessary "compensation" added to the actual scale length that will provide accurate string intonation at the saddle.



Staying on the fretboard's centerline, move the end of the straightedge to align with the center of the 12th fret, letting the straightedge extend over the bridge. The second (compensation) mark on the straightedge should rest over the center of the saddle slot's thickness, midway between the 3rd and 4th string bridge pin holes, when the bridge is positioned laterally on the soundboard's centerline. Mark the bridge's front edge location with a small piece of masking tape on the soundboard.

To determine the correct lateral bridge position, place the straightedge against each side of the fretboard, extending over the bridge. Center the bridge pin holes between the straightedge positions, and mark the bridge's side locations on the soundboard with masking tape. To "square-up" the final location, be sure both sides of the bridge's front edge are equidistant from the last fret.

Prepare three small wooden clamping cauls to fit over the

Installing the bridge

Apply Titebond to the bridge, and reclamp the bridge in place on the soundboard. Use at least three deep-throat clamps with your exterior and interior bridge cauls (**pictured**). Clean up the squeezed-out glue with a damp cloth, and allow at least 24 hours drying time.

Fitting the bridge pins

When the glue has dried, remove the center clamp to expose the bridge pin holes, leaving the outer clamps to hold the interior bridge caul in place. The caul will act as a backing block to prevent wood from splitting out as you drill.

Drill the holes through the soundboard, and into the caul, with a 3/16" drill bit (**pictured**). We recommend using a



center and sides of the bridge (**pictured**). Use a hand plane, file or sandpaper to match the bridge's contours, and glue sandpaper to the bottom of each caul to help keep it steady when clamped.

Align the bridge with the tape on the soundboard. Dry-clamp it with a deep-throat clamp to the internal bridge clamping caul you prepared earlier in the kit assembly, and the center exterior bridge caul. Using a sharp X-Acto knife, carefully scribe tightly around the bridge's outline (**pictured**). The knife blade should cut only through the lacquer finish, in several light passes.

Remove the bridge and the masking tape, and mask the soundboard around the bridge. Strip the lacquer from inside the scribed outline, using the same cautions and techniques you used for the fretboard extension. When the finish is removed, wipe the exposed wood carefully with a damp cloth to neutralize the remaining stripper, and let the area dry.



bridge pin reamer for tapering the holes to fit the supplied bridge pins.

Use a section of coping saw blade or jig saw blade, with the teeth cutting on the upstroke to avoid tear-out, to form slight notches in the bridge, soundboard and bridge plate. These slots will accommodate the strings, and should be

slightly deeper than the diameter of the string wrap near the ball end. The slot widths should match the diameters of the strings with the wrap, use a string of each gauge and install the string and bridge pin to check the fit and adjust the slot depth until the bridge pin is fully seated at the proper height. The slot widths should match the diameters of the strings. Clean the saw marks with a needle file, and file a slight “ramp” at the upper edge of each bridge pin hole to soften the angle of the string (see the blueprint).



Fitting the bridge saddle

The slot in the bridge runs completely through the top of the bridge and is 3/32" wide. The saddle must be thinned and ends trimmed to fit.

Thickness sand (**pictured**): Attach two pieces of adhesive backed sandpaper, 100-grit and 220-grit, to a hard flat surface. Sand the flat sides of the saddle blank back and forth on the papers.

Check the saddle thickness frequently by attempting to slide it into the slot. Work slowly and test often. It's important to try to sand evenly so one end doesn't get thinner than the other. It's helpful to rotate the piece every few strokes and flip it over occasionally so you don't accidentally apply too much pressure in any one spot. Go slow. You can always remove a little more material, but once you've gone too far, it's impossible to add it back on!

The fit should be tight and difficult to remove with just finger pressure, and you want to make sure the bottom of the saddle makes contact with the bottom of the slot. When you get the thickness right, you'll feel the saddle “click” into the slot when it reaches the bottom. Remember, the taller side of the saddle radius is for the bass strings.

Now it's time to trim the saddle to length and shape the ends: Fit the saddle into slot. Lightly mark the curve of the bridge onto the protruding saddle with a pencil and cut it 1/32" oversize to the line. Then using a round file or a dowel wrapped in sandpaper shape the ends of the saddle to blend them with the contour of the bridge (**illustrated**). Again, go

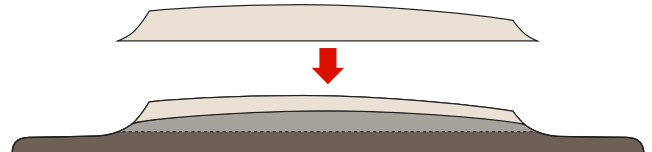

slow. You don't want to remove wood from the bridge and you want to achieve a smooth transition where the bone and wood meet. Switching to higher and higher grits of sand paper as you get closer to the final shape helps with this process. When the fit is perfect hand polishing the bridge and ends of the saddle with micromesh will give the bridge a nice shine and smooth feel.

You'll adjust the bridge height later during setup.

Installing the tuning machines

Lightly twist your reamer in the bushing holes on the peghead face, just enough to clean the lacquer and polishing residue from the edges. Carefully press the tuner bushings into the holes. Take care not to crack the lacquer finish (heating the bushings with a soldering iron can help if needed). With the tuners in place on the peghead, mark the mounting

holes with a scribe or an awl through the small holes on the baseplate. Remove the tuners, and drill the holes with the correct size drill bit. The tuning machines and screws can now be mounted.

Seating the strings

Use either medium or light gauge strings. Install each string so that it seats into the bridge pin hole notch. The bridge pin should hold the string as well, and the ball end should be snug against the bridge plate under the soundboard. Align the ball end with the string (**pictured**). Thread the strings loosely into the tuners.



Understanding neck relief

Neck “relief,” the upward curvature of the neck in the direction of the string’s pull, is adjusted with the truss rod. You should set the neck relief before final adjustment of the nut and saddle heights. Although the truss rod will affect string height, it shouldn’t be used to do so. It’s intended to control the relief, which can affect “buzzing” in the lower frets. Depending on your playing style and the accuracy of the fret heights, the neck should have anywhere from zero (straight) to 0.012" of relief. A straight neck tends to play better, but few guitars end up with no relief at all, and several thousandths or more is perfectly normal.

Start with the nut and saddle roughed out to height, and the guitar tuned to pitch. With a straightedge resting on the frets, along the centerline of the neck, use feeler gauges between the seventh fret and the straightedge to determine the amount of relief. The heavier you strum, the more relief you’ll need. Bluegrass players may need more relief, finger-pickers less, and the majority of players will be somewhere in between.

KIT TIP: Feeler gauges

Unwound guitar strings make excellent feeler gauges for measuring relief. Turning the truss rod nut clockwise straightens the neck and reduces the relief.

Turning it counterclockwise bows the neck upward, adding relief. Always adjust the truss rod with care — a little bit goes a long way.



Turn the truss rod nut counterclockwise to bring the neck up, adding relief.



Turn the nut clockwise to pull the neck back, reducing relief.

Adjusting string action: nut slots and saddle height

The first stage of setup will produce a medium-high action (this may be suitable for bluegrass players, but can be lowered for other playing styles). The heights of the nut and the saddle should be adjusted together; changes in one will affect the other. Adjust the truss rod to make the fretboard playing surface as straight as possible. If your neck has uneven fret heights, you must level them in order to “read” the frets accurately (see “Leveling the frets”).

Install the two outside E-strings to establish the string clearance over the first fret and the saddle height above the top of the bridge. The latter two measurements determine the action height, judged by measuring string clearance at the 12th fret.

Install a guitar capo behind the first fret and tighten it just enough to pull the strings down for clearance between the



bottom of the strings and the top of the first fret. Set this clearance at about .020" below the treble E-string, and .030" below the bass E-string. Use .020" and .030" guitar strings to measure the clearance as the capo is tightened (**pictured**). Now measure the overall string action at the 12th fret.

A comfortable medium action is about 3/32" to 7/64" under the bass E-string, and 1/16" to 5/64" under the treble E-string.

Your bridge saddle may be too tall. Decide how much each string must be lowered at the 12th fret. Twice that amount must be removed from the saddle height (this is a proven formula for lowering or raising the strings accurately).

With a through saddle you must remove material from the top of the saddle, because the lower portion of the saddle is matched to the bridge. Remove the saddle and measure down from the top of the saddle to determine the required amount to be removed. Use the same sanding method as recommended in "Fitting the bridge saddle." sanding evenly. Work slowly and test often. You can remove a little more, but once you've gone too far, it's impossible to add it back on!

Install the remaining strings and tune to standard pitch. Using a small razor saw and several nut-slotting files, lower the strings, one at a time, until they're close to the desired clearance over the first fret as measured with feeler gauges. Here are good clearances: E (1st), 0.012"; B (2nd), 0.012"; G (3rd), 0.014"; D (4th), 0.014"; A (5th), 0.016"; E (6th), 0.016".

When filing the nut slots, angle the file downward toward the peghead, and toward the appropriate tuning machine string post (**pictured**). The bottom of each slot should be slightly rounded, so each string will fit without binding.

When the slots are correct, remove the nut by gently tapping it from the front and back sides to unseat it, and then pry



it upward gently. Place the nut in a vise, and file down the top surface until the slots are approximately half as deep as their string diameters. Re-contour the upper edges of the nut, using a file, sandpapers and polishing compound.

Leveling the frets

Reinstall the nut (without glue) and play the guitar. Check for false notes or string buzzes caused by uneven frets. Buzzing is corrected by leveling the frets.

Remove the strings and the nut, mask the soundboard around the fretboard, and the fretboard between the frets. Adjust the neck perfectly straight.

KIT TIP: Use your truss rod

Remember that you have a two-way adjustable truss rod that can help you straighten the fretboard in either direction for fret leveling! You will need to readjust the truss rod if you changed the adjustment during leveling.

Using a flat fine-tooth mill file, gently level the tops of the frets with long full-length strokes down the fretboard. Restore and polish the rounded crown on the top of each fret with a fret crowning file and/or 400 and 600-grit finishing papers. Work along the length of each fret to remove any scratches left by the leveling file.

Unmask everything. Lightly glue the nut in place with Titebond, and restring the guitar. The strings will hold the nut in place to dry.

KIT TIP: Ink the frets

Ink the top of each fret with a felt-tip marker pen; the frets will be level when all the marks begin to disappear.

Installing the pickguard

Place the pickguard in position on the soundboard. Be sure it fits and looks correct, and trim it with scissors if necessary. You must warm the material with a hair dryer to soften it before cutting carefully with scissors. If the pickguard is not flat after cooling off, place it on a flat surface and warm again and let it cool on the flat area. Sand the trimmed edges with 400-grit paper to remove the burr. Practice placing the pickguard in position before removing the backing from the adhesive surface.

KIT TIP: Pickguard placement

Mist the guitar top with a mixture of water and a little dishwashing soap. Remove the backing from the pickguard and carefully place the pickguard on the guitar top. The soap and water mixture will allow the pickguard to slide a little for exact placement. Working from the center of the pickguard, carefully squeegee out the water to remove bubbles and air pockets from beneath the pickguard, and let it dry overnight.

Installing the endpin and strap button

To install the endpin, mark the centerpoint of the endpin on the guitar's end trim strip (see the blueprint, upper left), using a centerpunch or an awl. With a 1/4" brad point bit, carefully drill a perpendicular hole completely through the tailblock at this location. Enlarge the hole with a tapered reamer until the endpin fits snugly.

The original guitars did not include a strap button, but we've included one to install if you wish. To install the strap button: measure down halfway between the bottom of the fretboard and the end of the heel on the treble side of the neck heel, and halfway between the center of the heel and where the neck meets the body (**pictured**), and mark a center point with an awl. Use a 3/32" drill bit with a piece of tape 7/8" up the bit as a depth stop guide. Drill at 90 degree angle from that point on the neck heel. **Visualize the path of the drill bit before drilling to avoid going through the other side of the heel.**

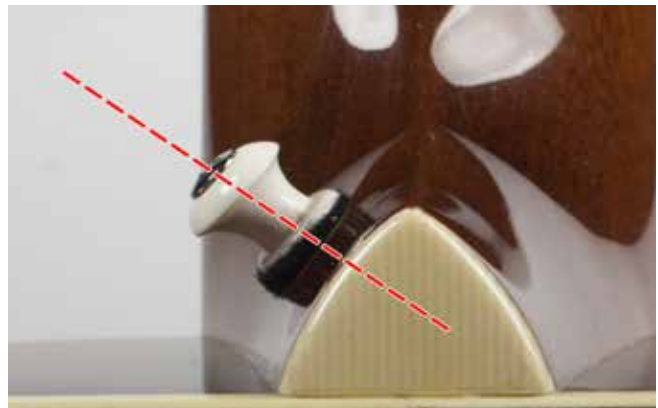

CONGRATULATIONS!

Now that your guitar is complete, we hope you enjoy playing it for many years. Protect it with a quality case, keep it away from extremes in temperature and humidity, and install only medium or lighter gauge strings.

And start building another guitar! You can't stop now can you?



21 N. Shafer St • Athens, Ohio 45701 • USA
USA & Canada call toll-free: **800-848-2273**
9am-5pm weekdays Eastern time

stewmac.com

i-WRM3JV
12/19